



BELGARD
PAVES THE WAY

RESOURCE GUIDE | CENTRAL PLAINS | KS, MO, NORTHWEST AR, NORTHEAST OK

LIFETIME TRANSFERABLE LIMITED WARRANTY

Oldcastle® APG, Inc. ("Belgard") is proud to inform you that all of our interlocking concrete paver and retaining walls ("Products") meet and/or exceed the requirements of ASTM C-936 and ASTM C-1372. Belgard® guarantees its Products against these standards for the lifetime of the Product defined by ICPI. This guarantee does not apply to splitting, chipping or other breakage that could be caused by impact, abrasion or overloading. This warranty is transferable. The original proof of purchase is required.

This warranty is only valid if the material is installed under the guidelines of the ICPI (www.ICPI.org), The NCMA (www.ncma.org) or the Belgard Installation Guideline Manual. Improper installation voids this warranty. This warranty is for residential applications only and does not apply to commercial applications. It is recommended that the job be installed by a Belgard Contractor Program participant who guarantees their workmanship for a minimum of 3 years from the date of install. For warranty service, contact Belgard at 877-BELGARD. A service representative will investigate your claim within 10 business days. If the Belgard product fails to meet the specifications, Belgard will replace the defective product at no charge. Color matching cannot be guaranteed. Belgard will not be responsible for any replacement labor, consequential damages or incidental damages. This warranty gives you specific legal rights, and you may also have other rights which vary from state to state. Some states do not allow for the exclusion or limitation of incidental or consequential damages, so the above limitation or exclusion may not apply to you.

For specific information regarding warranty coverage and exclusions in regards to the Elements™ and Porcelain Paver products, please visit: Belgard.com/Warranty.

ABOUT US

At Belgard®, we take our role as industry leaders seriously. Our rigorous research and development program is centered on innovation and quality. We never take it for granted that our products are the best in the business and constantly strive to improve and take the industry to the next level. Our overarching goal is to continue to find new and exciting ways to create beautiful outdoor spaces while maintaining incredibly high standards for product quality and performance.

Since 1995, our locally made and nationally backed products have transformed thousands of residential and commercial properties across North America. With more shapes, styles and textures than any other brand, Belgard's Outdoor Living paving and wall products aren't just functional, they infuse outdoor spaces with distinctive atmosphere and style.

Every day, our network of Belgard Authorized Dealers and Contractors helps customers realize their outdoor dreams. And every year, we strive to improve our product and service offerings by dedicating more than 20,000 hours to research and development. By staying ahead of design trends, we are able to provide design-forward products that homeowners envision for their backyard spaces.

All of our outdoor products—when installed by a Belgard Authorized Contractor—are covered by a transferable lifetime limited warranty. That's just part of our commitment to lasting outdoor beauty.

PAVERS & SLABS

PAVERS & SLABS INSTALLATION GUIDE

4 Interlocking Concrete Pavement

PAVERS & SLABS

5	Basalt™	25	Holland Stone
7	Belgian Cobble®	27	Mega-Arbel®
8	Brooklyn™	29	Melville™ Plank
10	Charlestone™	31	Melville™ Slab
12	Dimensions™ 6	33	Origins™ 6
12	Dimensions™ 12	33	Origins™ 12
14	Dimensions™ 18	35	Origins™ 18
17	Dimensions™ Slab		
20	Dimensions™ Accent & Origins™ Accent		
21	Dublin Cobble		
23	Geometric Shapes		

For basic paver installation information
visit icpi.org

INTERLOCKING CONCRETE PAVEMENT (ICP)

PATIO/WALK/RESIDENTIAL DRIVEWAY WITH PLASTIC EDGE RESTRAINT CROSS SECTION

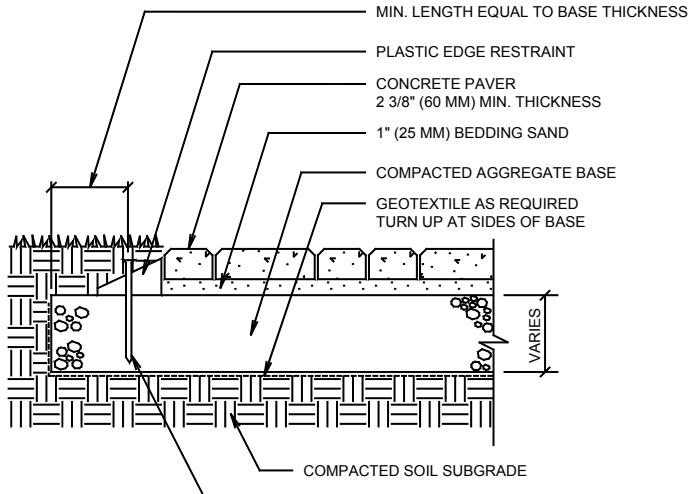

RESIDENTIAL DRIVEWAY WITH CONCRETE EDGES CROSS SECTION

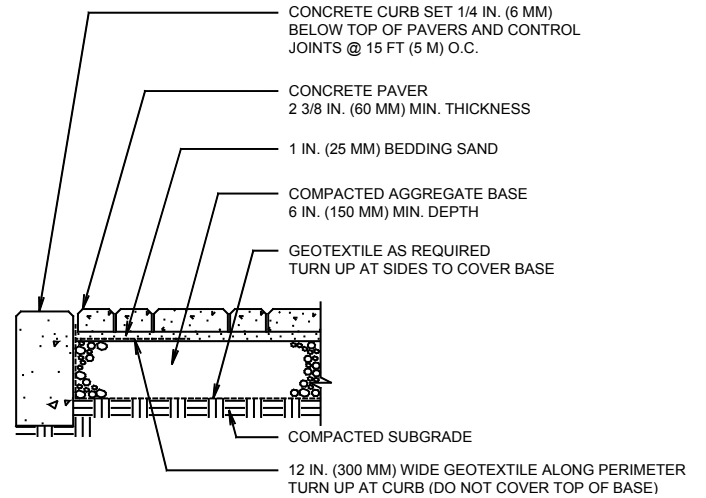

PATIO/SIDEWALK ON COMPACTED AGGREGATE BASE CROSS SECTION

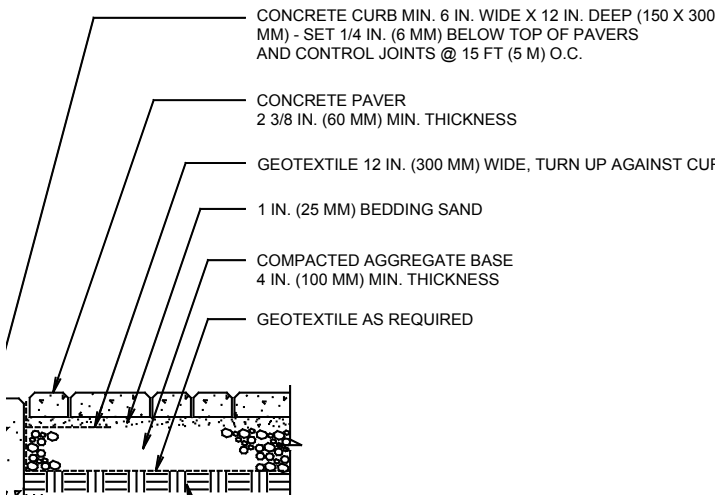

SWIMMING POOL DECK AND COPING CROSS SECTION

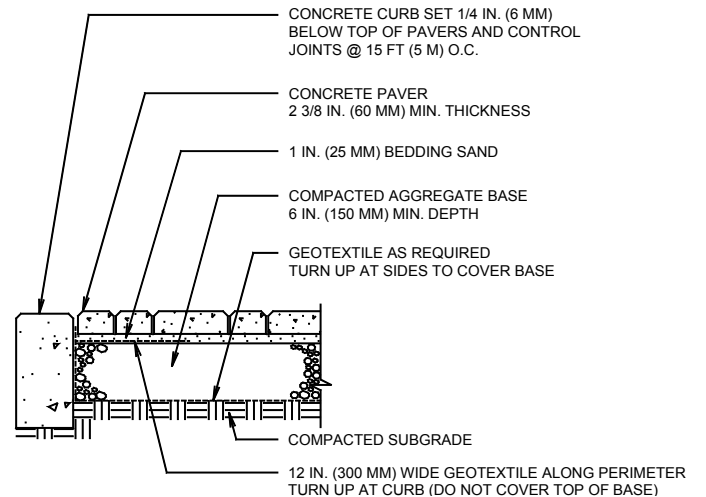



Scan for additional
product information

PEDESTRIAN	LIGHT/REGULAR TRAFFIC	HEAVY TRAFFIC	PERMEABLE	ADA	TRUECOLOR PROCESS
✓					✓

SHAPES & SIZES

Slab

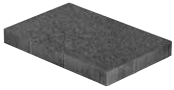

18 x 36 x 2³/₈

UNIT	SQFT/ PALLET	SQFT/ LAYER	LAYER/ PALLET	UNITS/ PALLET	UNITS/ LAYER	UNITS/ SQFT	WEIGHT/ PALLET
SLAB							
18 X 36 X 2 ³ / ₈	90	9	10	20	–	–	2578.7

NOTES:

AutoCAD® hatch pattern files can be downloaded from belgard.com for use in architectural drawings

Some patterns may not necessarily reflect the percentages of stone sizes within a particular pallet. In some cases you may have extras in one or more of the sizes. This must be accounted for in your planning and design.

Percentages are based on area by paver.

1-PIECE RUNNING BOND PATTERN

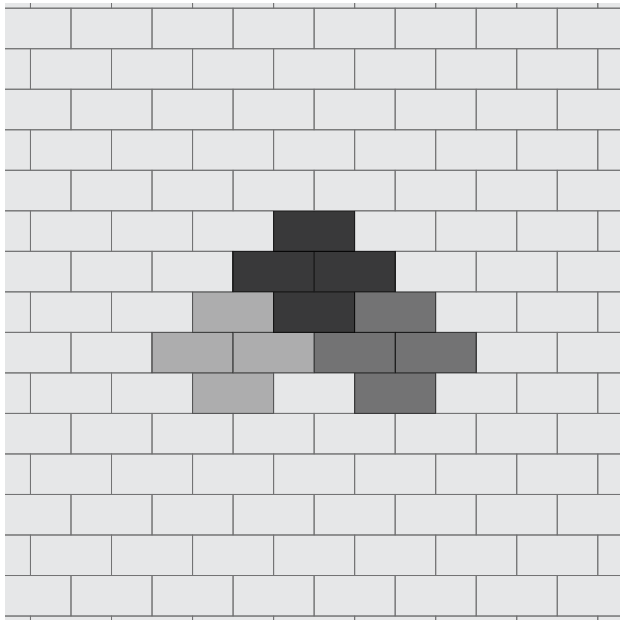

1-PIECE HERRINGBONE PATTERN

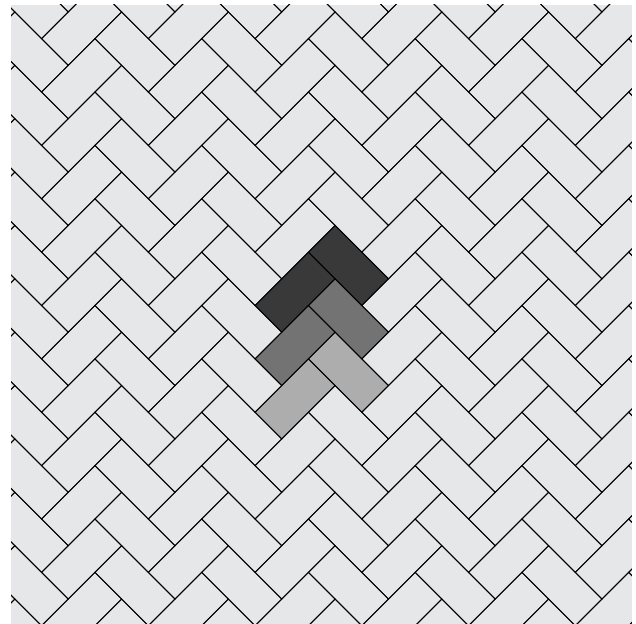



Scan for additional product information

PEDESTRIAN	LIGHT/REGULAR TRAFFIC	HEAVY TRAFFIC	PERMEABLE	ADA
✓	✓		✓	

SHAPES & SIZES

Multi-Piece



Variable x 2³/₈

UNIT	SQFT/ PALLET	SQFT/ LAYER	LAYER/ PALLET	UNITS/ PALLET	UNITS/ LAYER	UNITS/ SQFT	WEIGHT/ PALLET
MULTI-PIECE							
VARIABLE X 2³/₈	68	-	-	320	-	-	1640

Lay pavers at random.



Scan for additional
product information

PEDESTRIAN	LIGHT/REGULAR TRAFFIC	HEAVY TRAFFIC	PERMEABLE	ADA	T2 PROCESS
✓	✓				✓

SHAPES & SIZES

60mm



3 x 9 x 2³/₈

UNIT	SQFT/ PALLET	SQFT/ LAYER	LAYER/ PALLET	UNITS/ PALLET	UNITS/ LAYER	SQFT/ UNIT	WEIGHT/ PALLET	LNFT/PALLET (SOLDIER)	LNFT/PALLET (SAILOR)
60MM									
3 X 9 X 2³/₈	103.13	10.3	10	550	55	.188	2805	137.5	412.5

NOTES:

AutoCAD® hatch pattern files can be downloaded from belgard.com for use in architectural drawings.

Some patterns may not necessarily reflect the percentages of stone sizes within a particular pallet. In some cases you may have extras in one or more of the sizes. This must be accounted for in your planning and design.

Percentages are based on area by paver.

1-PIECE RUNNING BOND PATTERN

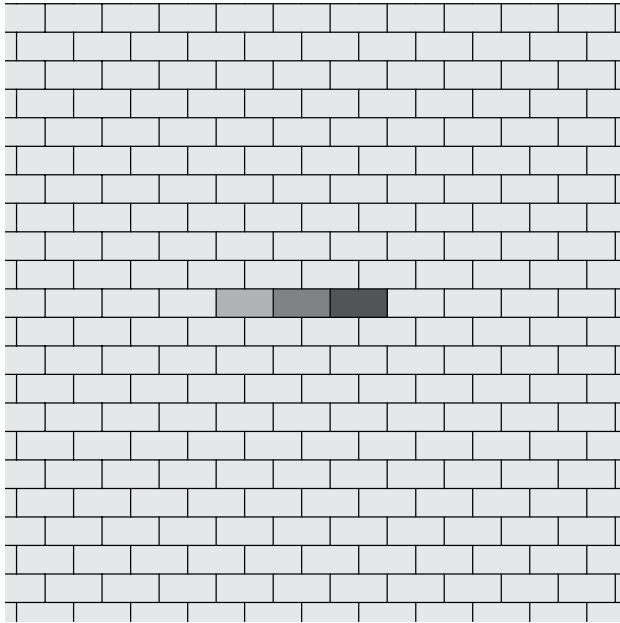

1-PIECE HERRINGBONE PATTERN

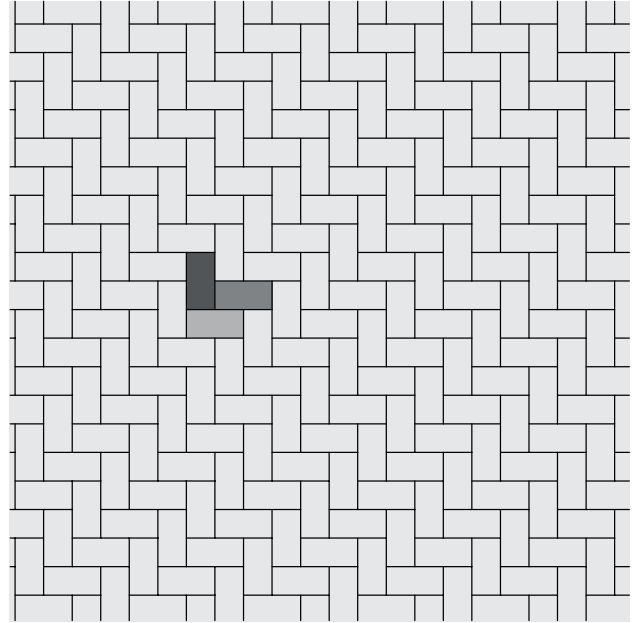

1-PIECE BASKET WEAVE PATTERN

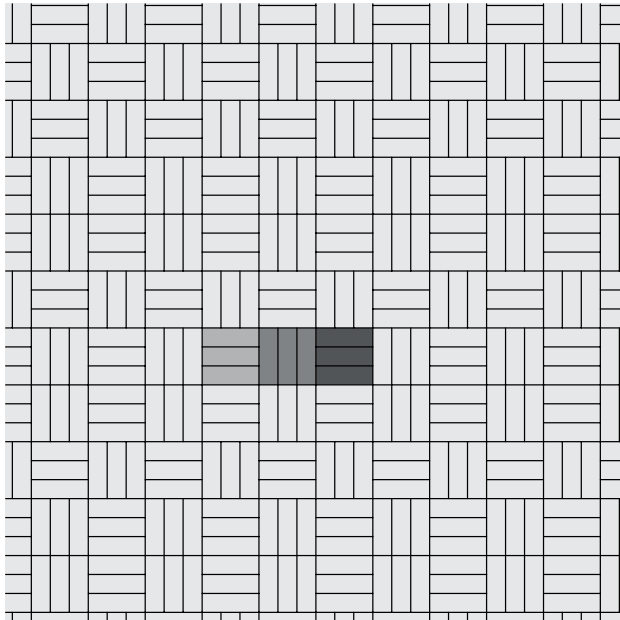



Scan for additional product information

PEDESTRIAN	LIGHT/REGULAR TRAFFIC	HEAVY TRAFFIC	PERMEABLE	ADA	TRUECOLOR PROCESS
✓	✓				✓

SHAPES & SIZES

3-Piece Modular



Available for Mechanical Installation



6 x 6 x 2³/₈



6 x 9 x 2³/₈



6 x 12 x 2³/₈

UNIT	SQFT/PALLET	SQFT/LAYER	LAYER/PALLET	UNITS/PALLET	UNITS/LAYER	SQFT/UNIT	WEIGHT/PALLET	LNFT/PALLET (SOLDIER)	LNFT/PALLET (SAILOR)
------	-------------	------------	--------------	--------------	-------------	-----------	---------------	-----------------------	----------------------

3-PIECE MODULAR

6 X 6 X 2 ³ / ₈	15	1.5	10	60	6	–	–	–	210
6 X 9 X 2 ³ / ₈	45	4.5	10	120	12	–	–	–	210
6 X 12 X 2 ³ / ₈	45	4.5	10	90	9	–	–	–	210

NOTES:

AutoCAD® hatch pattern files can be downloaded from belgard.com for use in architectural drawings

Some patterns may not necessarily reflect the percentages of stone sizes within a particular pallet. In some cases you may have extras in one or more of the sizes. This must be accounted for in your planning and design.



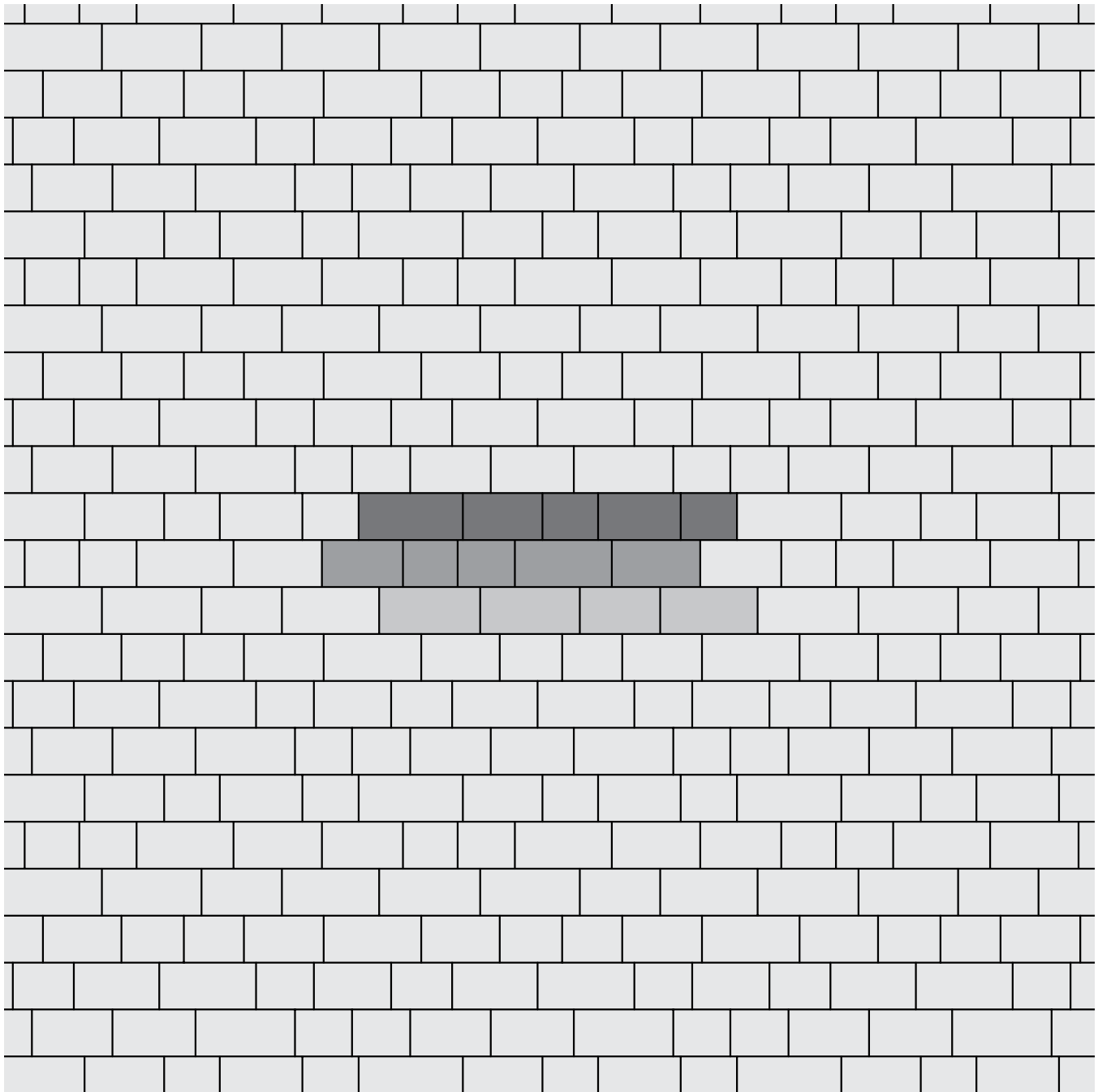



Percentages are based on area by paver.



DIMENSIONS™ 6 & 12



Scan for additional
product information

PEDESTRIAN	LIGHT/REGULAR TRAFFIC	HEAVY TRAFFIC	PERMEABLE	ADA	DURAFUSION PROCESS	TRUECOLOR PROCESS
						
✓	✓*			✓	✓**	✓**

*Only applicable for Dimensions 6 and accents.

**Durafusion and Truecolor process varies by product color.

SHAPES & SIZES

Dimensions 6 - 3-Piece



3 x 6 x 2³/₈



6 x 6 x 2³/₈



6 x 9 x 2³/₈

Dimensions 12 - 3-Piece



6 x 12 x 2³/₈



12 x 12 x 2³/₈



12 x 18 x 2³/₈

UNIT	SQFT/ PALLET	SQFT/ LAYER	LAYER/ PALLET	UNITS/ PALLET	UNITS/ LAYER	UNITS/ SQFT	WEIGHT/ PALLET	LNFT/PALLET (SOLDIER)	LNFT/PALLET (SAILOR)
------	-----------------	----------------	------------------	------------------	-----------------	----------------	-------------------	--------------------------	-------------------------

DIMENSIONS 6 - 3-PIECE

3 X 6 X 2 ³ / ₈	120	12	10	480	48	-	3325	160	240
6 X 6 X 2 ³ / ₈									
6 X 9 X 2 ³ / ₈									

DIMENSIONS 12 - 3-PIECE

6 X 12 X 2 ³ / ₈	120	12	10	120	12	-	3516	-	120
12 X 12 X 2 ³ / ₈									
18 X 12 X 2 ³ / ₈									

NOTES:

AutoCAD® hatch pattern files can be downloaded from belgard.com for use in architectural drawings.

Some patterns may not necessarily reflect the percentages of stone sizes within a particular pallet. In some cases you may have extras in one or more of the sizes. This must be accounted for in your planning and design.



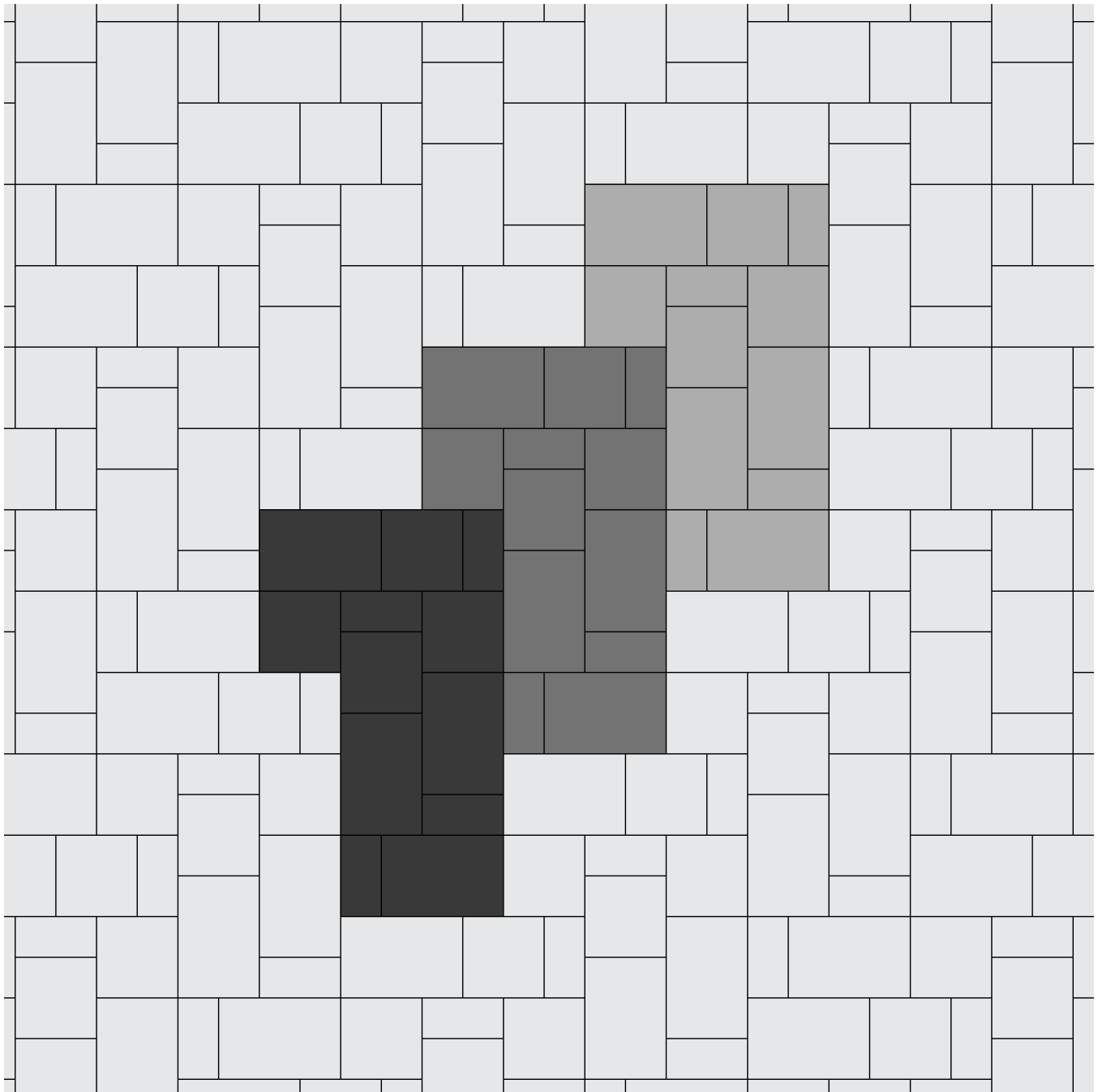



Percentages are based on area by paver.



DIMENSIONS™ 18



Scan for additional product information

PEDESTRIAN	LIGHT/REGULAR TRAFFIC	HEAVY TRAFFIC	PERMEABLE	ADA	DURAFUSION PROCESS	TRUECOLOR PROCESS
						
✓				✓	✓*	✓*

*Durafusion and Truecolor process varies by product color.

SHAPES & SIZES

3-Piece



9 x 18 x 2³/₈



18 x 18 x 2³/₈



18 x 27 x 2³/₈

UNIT	SQFT/PALLET	SQFT/LAYER	LAYER/PALLET	UNITS/PALLET	UNITS/LAYER	UNITS/SQFT	WEIGHT/PALLET	LNFT/PALLET (SOLDIER)	LNFT/PALLET (SAILOR)
------	-------------	------------	--------------	--------------	-------------	------------	---------------	-----------------------	----------------------

3-PIECE

9 X 18 X 2 ³ / ₈ 18 X 18 X 2 ³ / ₈ 27 X 18 X 2 ³ / ₈	112.5	11.3	10	50	5	–	3152	–	–
--	-------	------	----	----	---	---	------	---	---



NOTES:

AutoCAD® hatch pattern files can be downloaded from belgard.com for use in architectural drawings.

Some patterns may not necessarily reflect the percentages of stone sizes within a particular pallet. In some cases you may have extras in one or more of the sizes. This must be accounted for in your planning and design.

Percentages are based on area by paver.

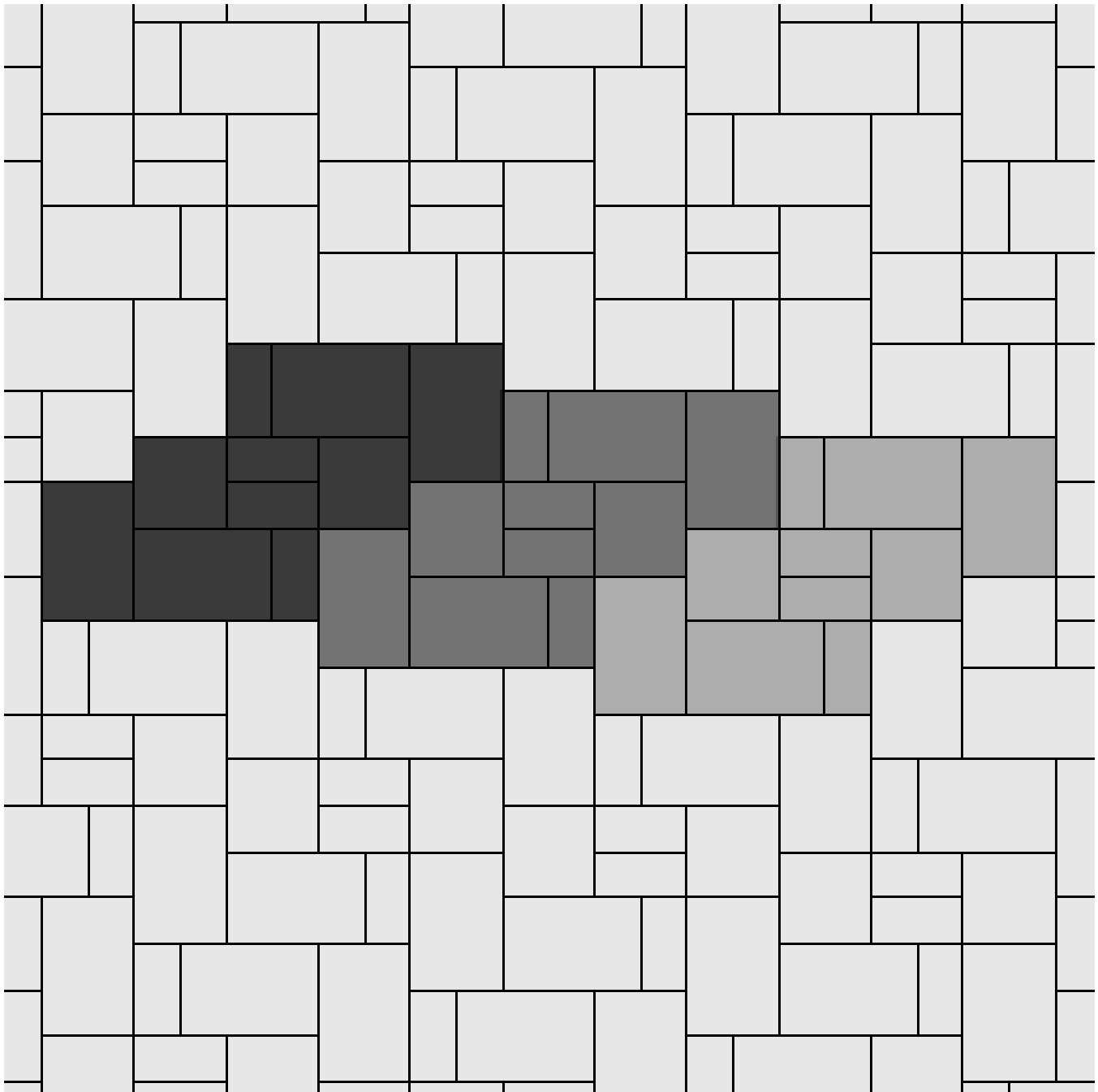



NOTES:

AutoCAD® hatch pattern files can be downloaded from belgard.com for use in architectural drawings.

Some patterns may not necessarily reflect the percentages of stone sizes within a particular pallet. In some cases you may have extras in one or more of the sizes. This must be accounted for in your planning and design.



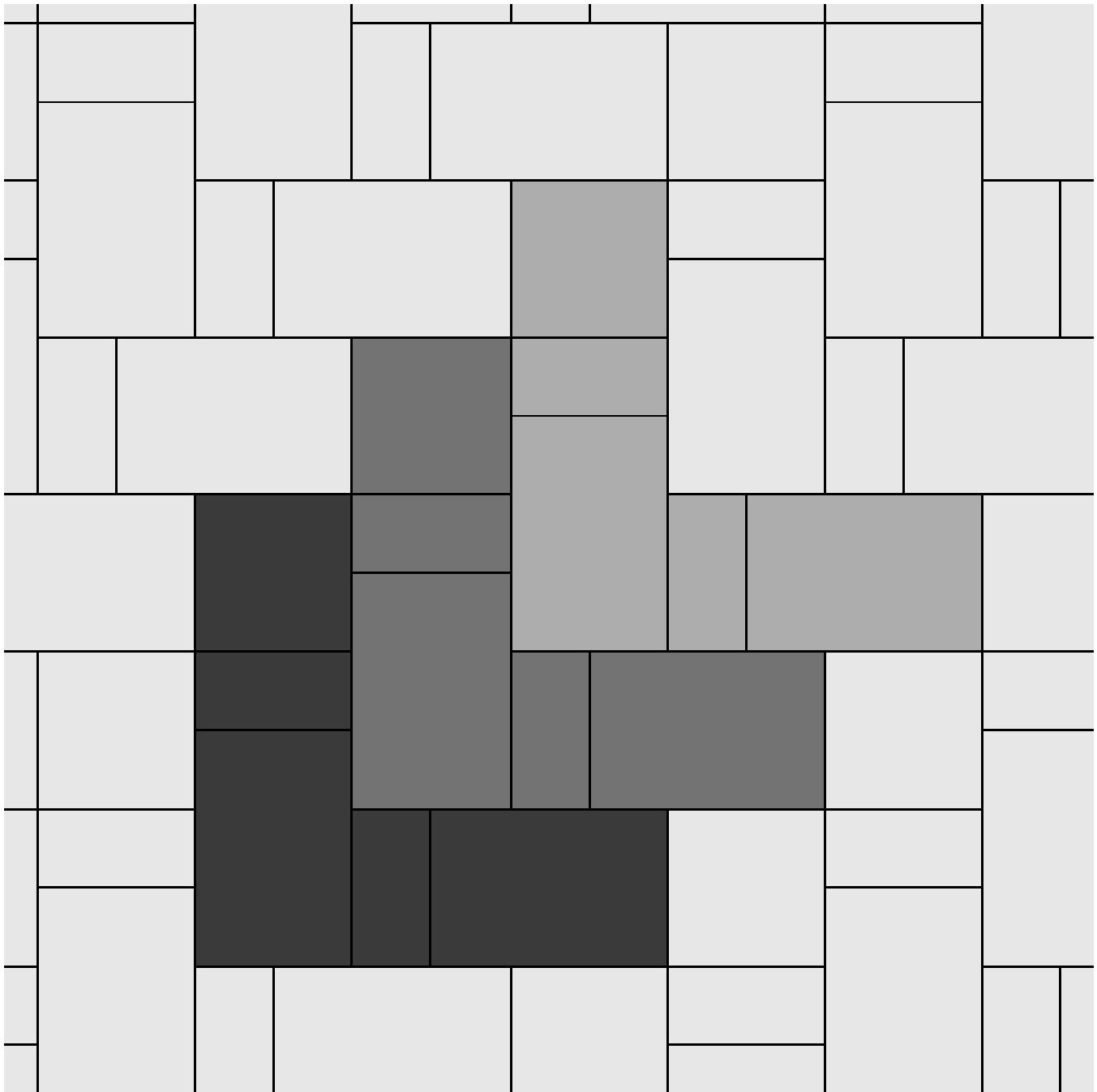



Percentages are based on area by paver.



DIMENSIONS™ SLABS



Scan for additional product information

PEDESTRIAN	LIGHT/REGULAR TRAFFIC	HEAVY TRAFFIC	PERMEABLE	ADA	DURAFUSION PROCESS	TRUECOLOR PROCESS
						
✓				✓	✓*	✓*

*Durafusion and Truecolor process varies by product color.

SHAPES & SIZES

Slab 12 x 24

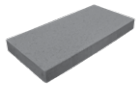

12 x 24 x 2³/₈

Slab 24 x 24

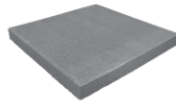

24 x 24 x 2³/₈

Slab 24 x 36

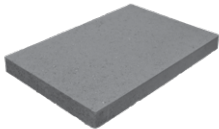

24 x 36 x 2³/₈

Slab 18 x 36

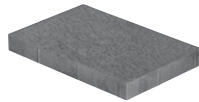

18 x 36 x 2³/₈

UNIT	SQFT/ PALLET	SQFT/ LAYER	LAYER/ PALLET	UNITS/ PALLET	UNITS/ LAYER	UNITS/ SQFT	WEIGHT/ PALLET	LNFT/PALLET (SOLDIER)	LNFT/PALLET (SAILOR)
SLAB 12 X 24									
12 X 24 X 2³/₈	120	12	10	60	6	–	3384	60	120
SLAB 24 X 24									
24 X 24 X 2³/₈	80	12	10	20	2	–	2256	40	40
SLAB 24 X 36									
24 X 36 X 2³/₈	120	12	10	20	2	–	–	40	120
SLAB 18 X 36									
18 X 36 X 2³/₈	90	9	10	20	–	–	2578.74	–	–

3-PIECE PATTERN A

12 x 24, 24 x 24, 24 x 36

NOTES:

AutoCAD® hatch pattern files can be downloaded from belgard.com for use in architectural drawings.

Some patterns may not necessarily reflect the percentages of stone sizes within a particular pallet. In some cases you may have extras in one or more of the sizes. This must be accounted for in your planning and design.

Percentages are based on area by paver.

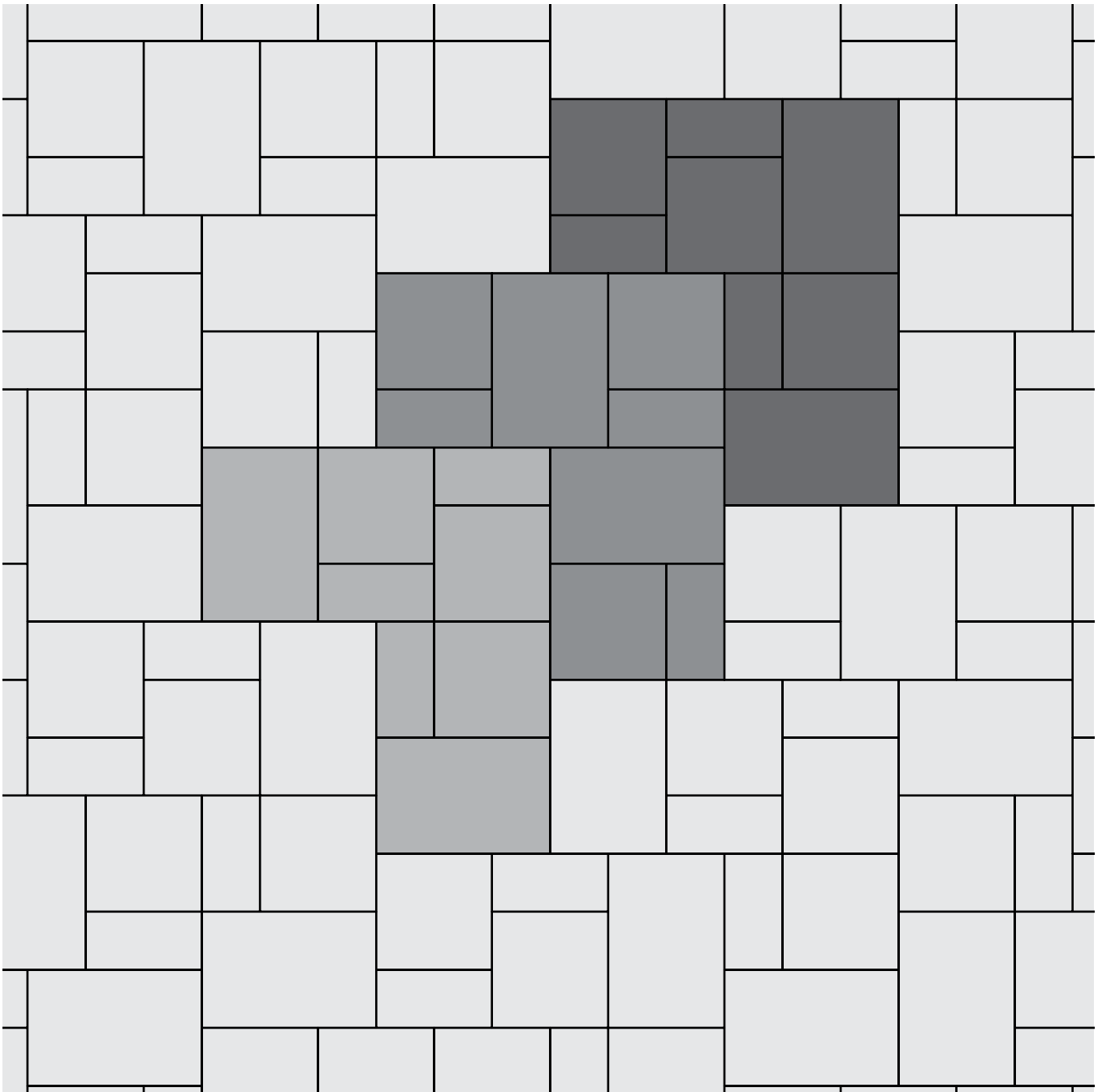

NOTES:

AutoCAD® hatch pattern files can be downloaded from belgard.com for use in architectural drawings

Some patterns may not necessarily reflect the percentages of stone sizes within a particular pallet. In some cases you may have extras in one or more of the sizes. This must be accounted for in your planning and design.

Percentages are based on area by paver.

1-PIECE RUNNING BOND PATTERN

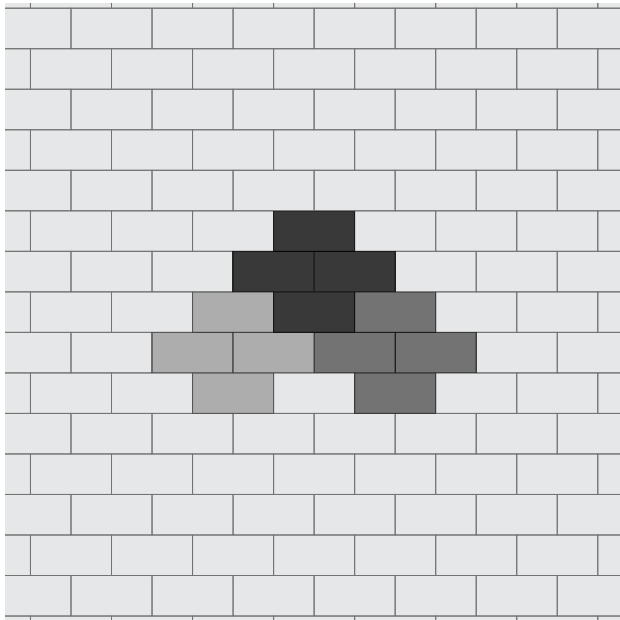

1-PIECE HERRINGBONE PATTERN

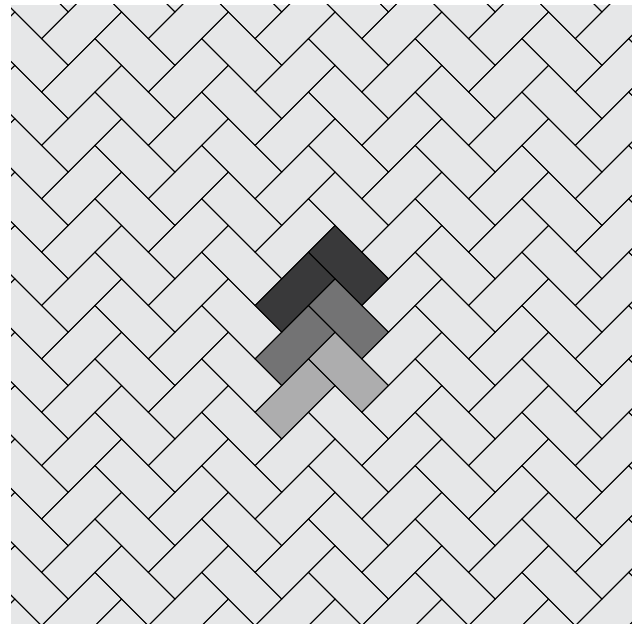

DIMENSIONS™ ACCENT & ORIGINS™ ACCENT

METROPOLITAN
COLLECTION

NATURAL
COLLECTION



Scan for additional
product information
for Dimensions™



Scan for additional
product information
for Origins™

PEDESTRIAN	LIGHT/REGULAR TRAFFIC	HEAVY TRAFFIC	PERMEABLE	ADA	DURAFUSION PROCESS	TRUECOLOR PROCESS
✓	✓*			✓	✓**	✓**

*Only applicable for Dimensions 6 and accents.

**Durafusion and Truecolor process varies by product color.

SHAPES & SIZES

Dimensions Accent 3 x 9



3 x 9 x 2³/₈

Dimensions Accent 6 x 9

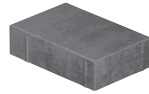

6 x 9 x 2³/₈

Origins Accent 6 x 9

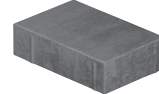

6 x 9 x 2³/₈

UNIT	SQFT/ PALLET	SQFT/ LAYER	LAYER/ PALLET	UNITS/ PALLET	UNITS/ LAYER	UNITS/ SQFT	WEIGHT/ PALLET	LNFT/PALLET (SOLDIER)	LNFT/PALLET (SAILOR)
------	-----------------	----------------	------------------	------------------	-----------------	----------------	-------------------	--------------------------	-------------------------

DIMENSIONS ACCENT 3 X 9

3 X 9 X 2 ³ / ₈	103	10.3	10	550	55	–	2805	137.5	412.5
---------------------------------------	-----	------	----	-----	----	---	------	-------	-------

DIMENSIONS ACCENT 6 X 9







6 X 9 X 2 ³ / ₈	120	12	10	320	30	–	3328	160	240
---------------------------------------	-----	----	----	-----	----	---	------	-----	-----

ORIGINS ACCENT 6 X 9

6 X 9 X 2 ³ / ₈	120	12	10	320	32	–	3328	160	240
---------------------------------------	-----	----	----	-----	----	---	------	-----	-----



Scan for additional product information

PEDESTRIAN	LIGHT/REGULAR TRAFFIC	HEAVY TRAFFIC	PERMEABLE	ADA	DURAFUSION PROCESS
					
✓	✓	✓			

SHAPES & SIZES

3-Piece Modular



3 x 6 x 2³/₈



6 x 6 x 2³/₈



6 x 9 x 2³/₈

UNIT	SQFT/PALLET	SQFT/LAYER	LAYER/PALLET	UNITS/PALLET	UNITS/LAYER	UNITS/SQFT	WEIGHT/PALLET	LNFT/PALLET (SOLDIER)	LNFT/PALLET (SAILOR)
3-PIECE									
6 X 3 X 2³/₈	20.84	1.89	–	176	–	–	–	–	–
6 X 6 X 2³/₈	44.98	3.91	–	176	–	–	–	–	–
6 X 9 X 2³/₈	64.20	5.84	–	176	–	–	–	–	–
TOTAL	128	11.63	11	528	48	–	3200	170	256

NOTES:

AutoCAD® hatch pattern files can be downloaded from belgard.com for use in architectural drawings.

Some patterns may not necessarily reflect the percentages of stone sizes within a particular pallet. In some cases you may have extras in one or more of the sizes. This must be accounted for in your planning and design.

3-PIECE PATTERN A

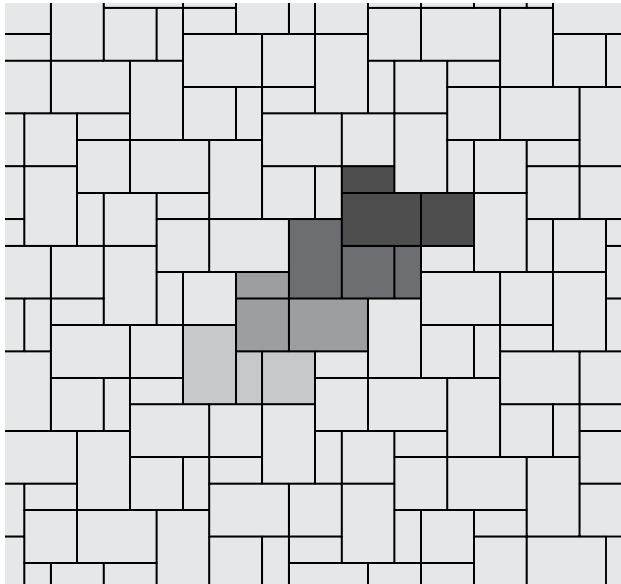

17% - 6 x 3 | 33% - 6 x 6 | 50% - 6 x 9

3-PIECE Running Bond

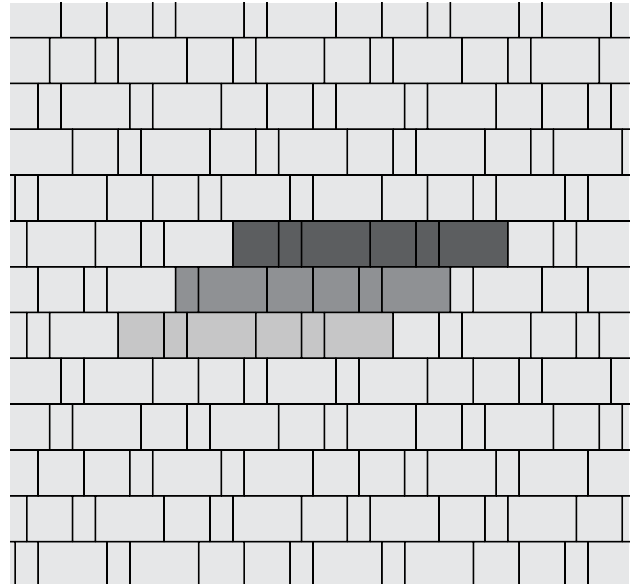







17% - 6 x 3 | 33% - 6 x 6 | 50% - 6 x 9

GEOMETRIC SHAPES



Scan for additional product information

PEDESTRIAN	LIGHT/REGULAR TRAFFIC	HEAVY TRAFFIC	PERMEABLE	ADA	DURAFUSION PROCESS	TRUECOLOR PROCESS
						
✓	✓			✓		✓

SHAPES & SIZES

Hexagon

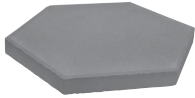

10⁷/₁₆ x 11⁷/₈ x 2³/₈

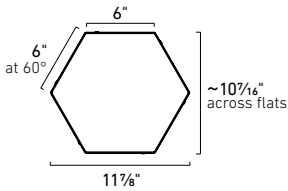

Diamond

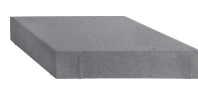

12 x 12 x 2³/₈

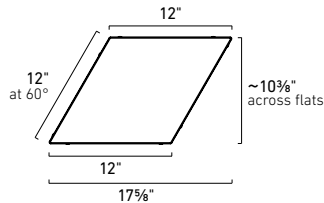

3 x 12 Parallelogram

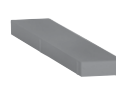

3 x 12 x 2³/₈

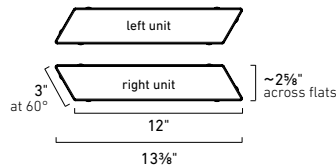

6 x 18 Parallelogram

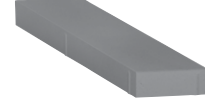

6 x 18 x 2³/₈

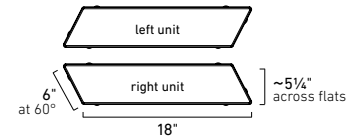

UNIT	SQFT/PALLET	SQFT/LAYER	LAYER/PALLET	UNITS/PALLET	UNITS/LAYER	UNITS/SQFT	WEIGHT/PALLET	LNFT/PALLET (SOLDIER)	LNFT/PALLET (SAILOR)
HEXAGON									
10 ⁷ / ₁₆ X 11 ⁷ / ₈ X 2 ³ / ₈	100.02	–	11	154	–	–	2845	–	–
DIAMOND									
12 X 12 X 2 ³ / ₈	93.53	–	12	108	–	–	2664	–	–
3 X 12 PARALLELOGRAM									
3 X 12 X 2 ³ / ₈	85.73	–	11	396	–	–	2390	–	–
6 X 18 PARALLELOGRAM									
6 X 18 X 2 ³ / ₈	114.31	–	11	176	–	–	3165	–	–

NOTES:

AutoCAD® hatch pattern files can be downloaded from belgard.com for use in architectural drawings.

Some patterns may not necessarily reflect the percentages of stone sizes within a particular pallet. In some cases you may have extras in one or more of the sizes. This must be accounted for in your planning and design.

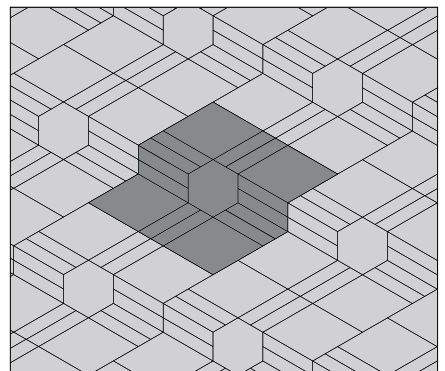
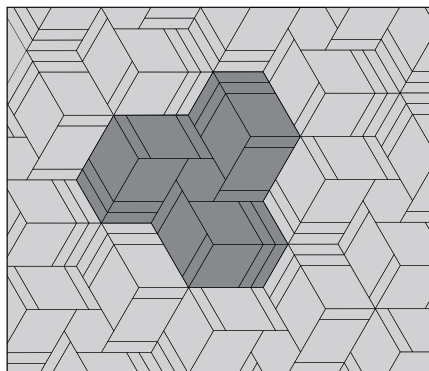
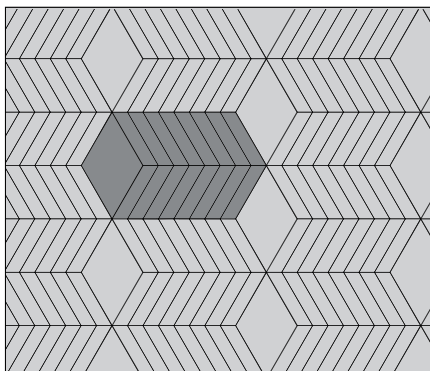
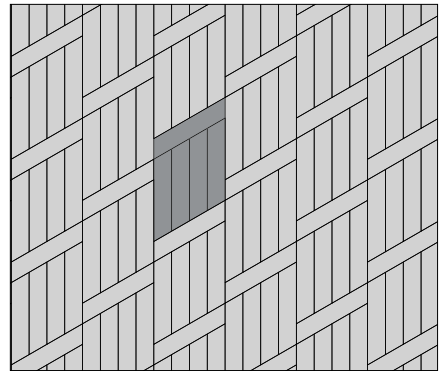
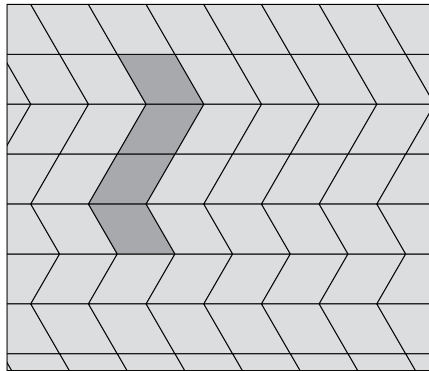
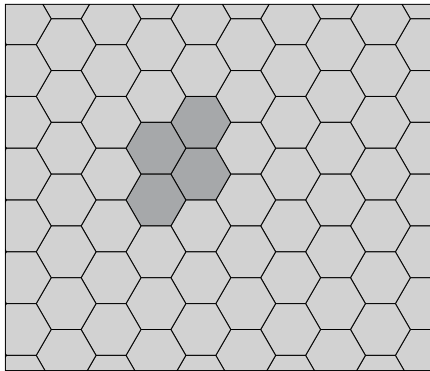



Scan for additional product information

PEDESTRIAN	LIGHT/REGULAR TRAFFIC	HEAVY TRAFFIC	PERMEABLE	ADA	TRUECOLOR PROCESS
✓	✓			✓	✓

SHAPES & SIZES

60mm



4 x 8 x 2³/₈

80mm*



4 x 8 x 3¹/₈

*Special Order Only

UNIT	SQFT/PALLET	SQFT/LAYER	LAYER/PALLET	UNITS/PALLET	UNITS/LAYER	UNITS/SQFT	WEIGHT/PALLET	LNFT/PALLET (SOLDIER)	LNFT/PALLET (SAILOR)
60mm									
4 X 8 X 2 ³ / ₈	120	12	10	540	54	–	3348	177.2	360
80mm*									
4 X 8 X 3 ¹ / ₈	96	17.50	6	432	81	–	3440	–	–

HOLLAND STONE

1-PIECE RUNNING BOND PATTERN

NOTES:

AutoCAD® hatch pattern files can be downloaded from belgard.com for use in architectural drawings.

Some patterns may not necessarily reflect the percentages of stone sizes within a particular pallet. In some cases you may have extras in one or more of the sizes. This must be accounted for in your planning and design.

Percentages are based on area by paver.

1-PIECE RUNNING BOND PATTERN

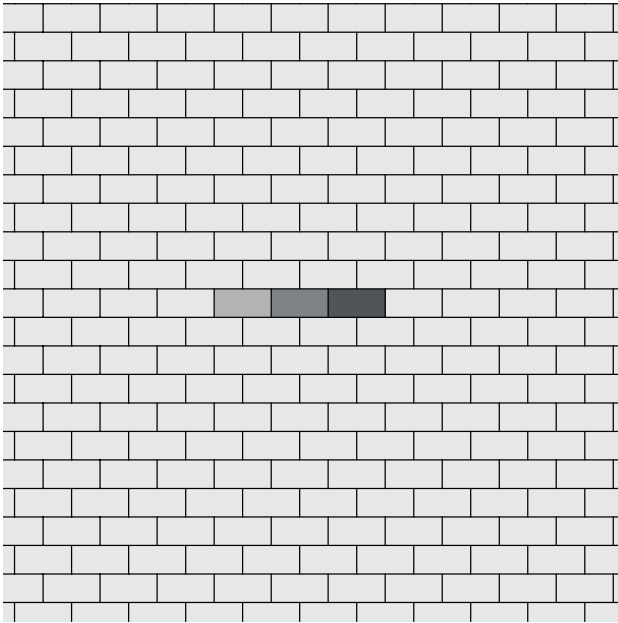

1-PIECE HERRINGBONE PATTERN

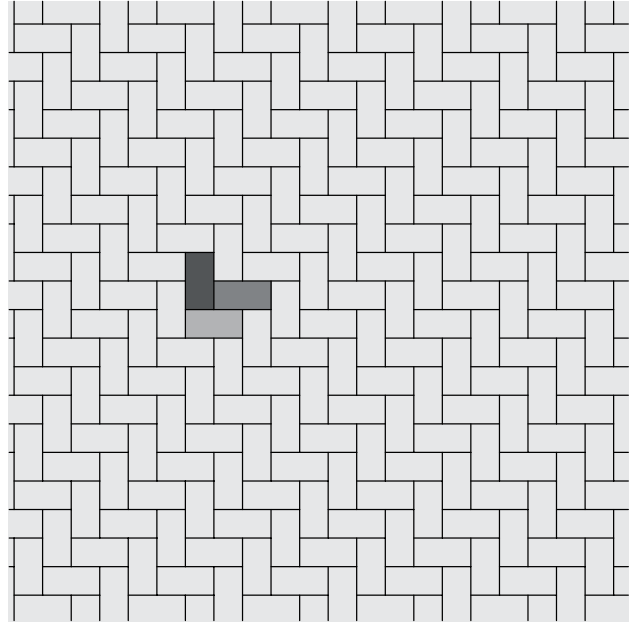



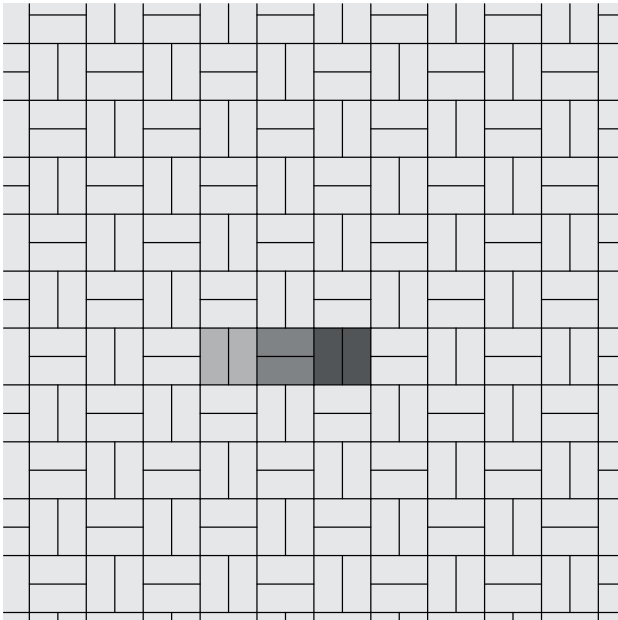



1-PIECE BASKET WEAVE PATTERN





Scan for additional
product information

PEDESTRIAN	LIGHT/REGULAR TRAFFIC	HEAVY TRAFFIC	PERMEABLE	ADA	TRUECOLOR PROCESS
					
✓					✓

SHAPES & SIZES

60mm



15³/₈ x 21 x 2³/₈

UNIT	SQFT/ PALLET	SQFT/ LAYER	LAYER/ PALLET	UNITS/ PALLET	UNITS/ LAYER	UNITS/ SQFT	WEIGHT/ PALLET
60mm							
15 ³ / ₈ X 21 X 2 ³ / ₈	103.4	8.62	12	72	6	–	2896



NOTES:

AutoCAD® hatch pattern files can be downloaded from belgard.com for use in architectural drawings.

Some patterns may not necessarily reflect the percentages of stone sizes within a particular pallet. In some cases you may have extras in one or more of the sizes. This must be accounted for in your planning and design.

Percentages are based on area by paver.



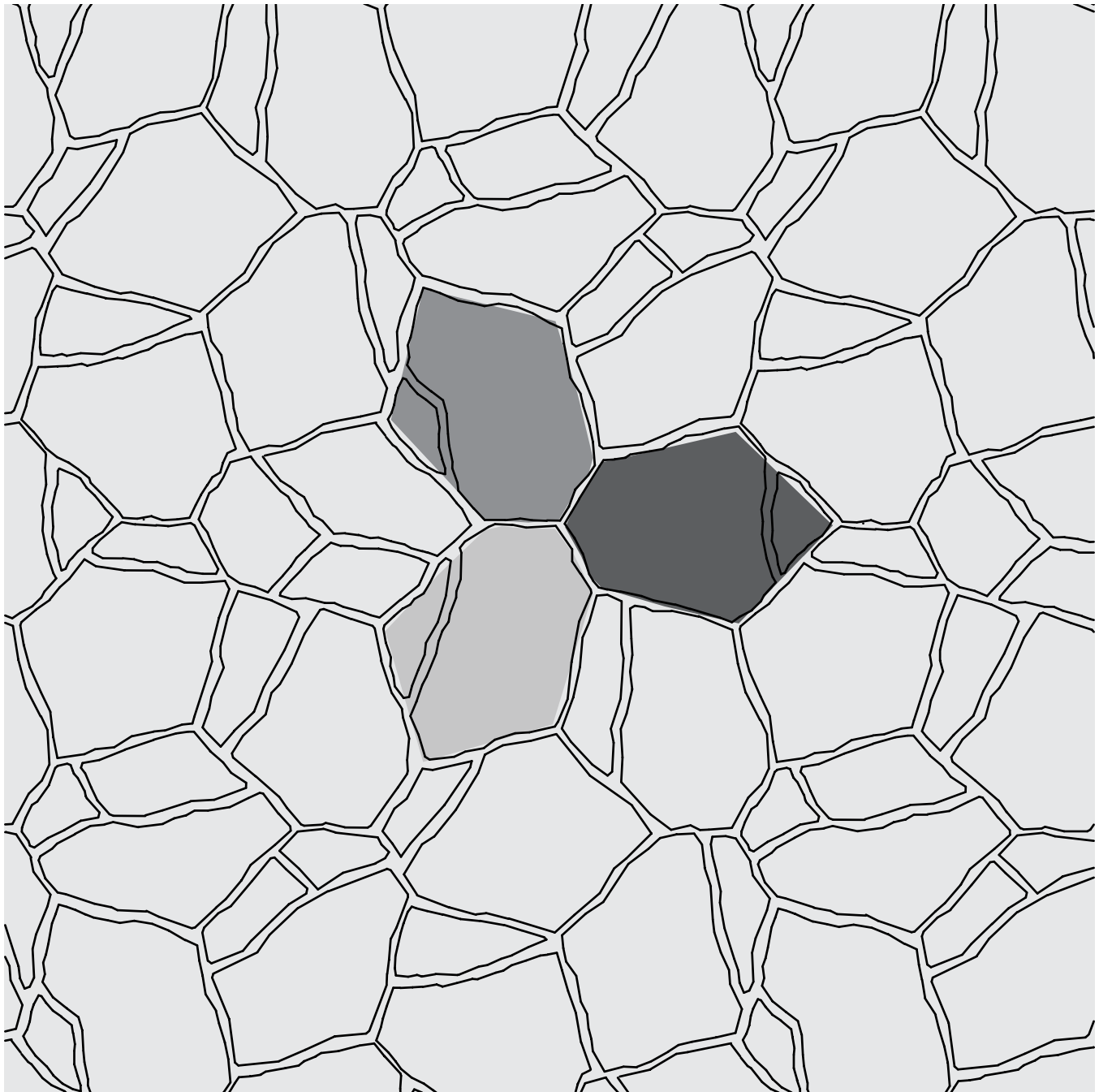



100% 15³/₈ x 21



MELVILLE™ PLANK



Scan for additional
product information

PEDESTRIAN	LIGHT/REGULAR TRAFFIC	HEAVY TRAFFIC	PERMEABLE	ADA	DURAFUSION PROCESS
					
✓				✓	✓

SHAPES & SIZES

3-Piece



$7\frac{1}{2} \times 11\frac{13}{16} \times 2\frac{3}{8}$

$7\frac{1}{2} \times 15\frac{3}{4} \times 2\frac{3}{8}$

$7\frac{1}{2} \times 19\frac{11}{16} \times 2\frac{3}{8}$

UNIT	SQFT/ PALLET	SQFT/ LAYER	LAYER/ PALLET	UNITS/ PALLET	UNITS/ LAYER	UNITS/ SQFT	WEIGHT/ PALLET	LNFT/PALLET (SOLDIER)	LNFT/PALLET (SAILOR)
------	-----------------	----------------	------------------	------------------	-----------------	----------------	-------------------	--------------------------	-------------------------

3-PIECE LARGE

$7\frac{1}{2} \times 11\frac{13}{16} \times 2\frac{3}{8}$	30.67	3.07	–	–	–	–	–	–	–
$7\frac{1}{2} \times 15\frac{3}{4} \times 2\frac{3}{8}$	40.9	4.09	–	–	–	–	–	–	–
$7\frac{1}{2} \times 19\frac{11}{16} \times 2\frac{3}{8}$	51.13	5.11	–	–	–	–	–	–	–
TOTAL	122.7	12.27	10	150	–	–	3500	–	275

NOTES:

AutoCAD® hatch pattern files can be downloaded from belgard.com for use in architectural drawings.

Some patterns may not necessarily reflect the percentages of stone sizes within a particular pallet. In some cases you may have extras in one or more of the sizes. This must be accounted for in your planning and design.

Percentages are based on area by paver.

25% 7½ x 11¹³/₁₆

33% 7½ x 15³/₄

42% 7½ x 19¹/₁₆

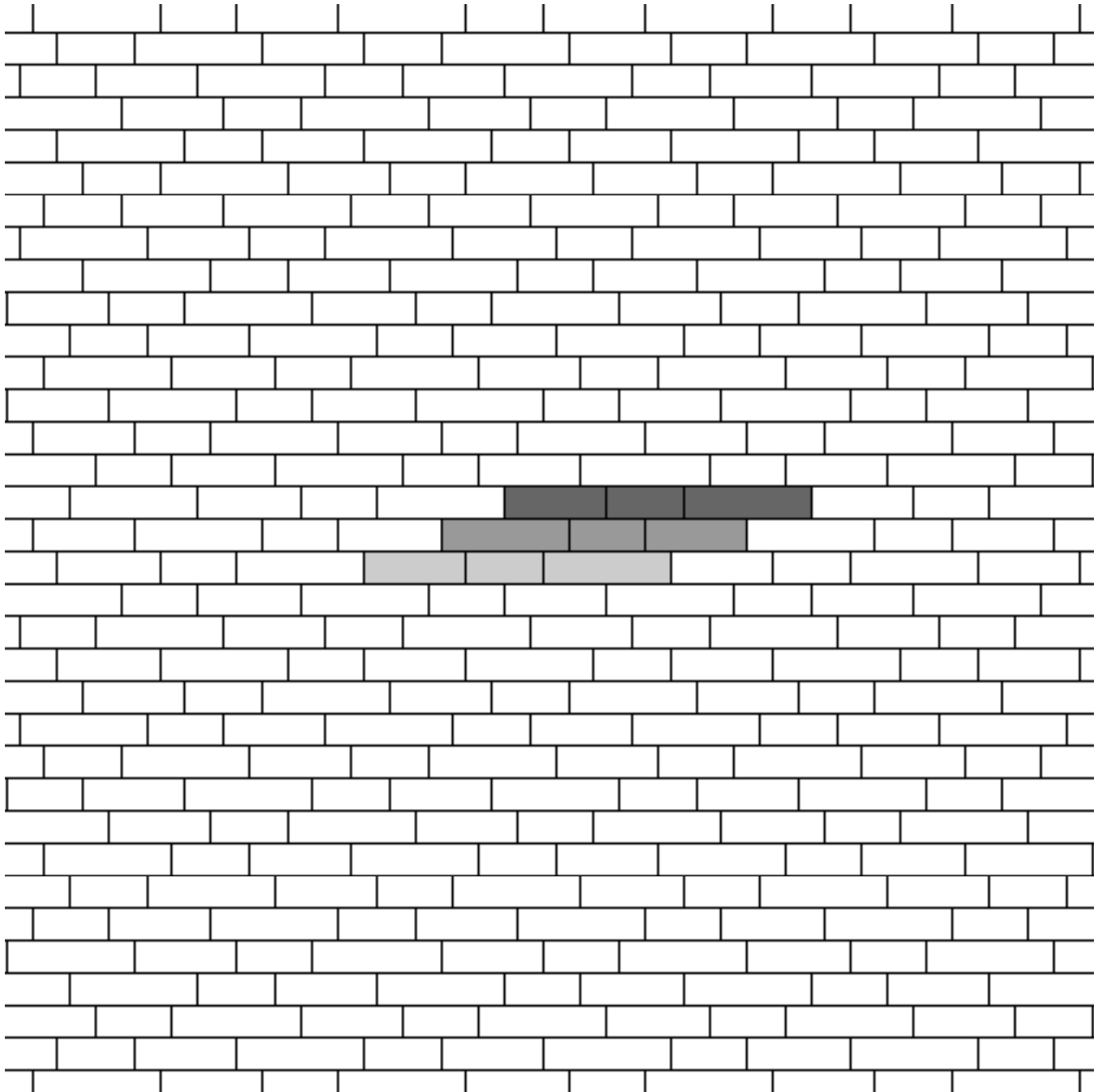







MELVILLE™ SLAB*

*Special Order Only



Scan for additional product information

PEDESTRIAN	LIGHT/REGULAR TRAFFIC	HEAVY TRAFFIC	PERMEABLE	ADA	DURAFUSION PROCESS
					
✓	✓				✓

SHAPES & SIZES

3-Piece Combo 80mm

Accent Piece



15 x 7½ x 3⅛



15 x 15¾ x 3⅛



15 x 22½ x 3⅛



15 x 7½ x 3⅛

UNIT	SQFT/PALLET	SQFT/LAYER	LAYER/PALLET	UNITS/PALLET	UNITS/LAYER	UNITS/SQFT	WEIGHT/PALLET
------	-------------	------------	--------------	--------------	-------------	------------	---------------

3-PIECE COMBO 80mm

3-PIECE COMBO	83.97	11.99	7	56	–	–	3079
TOTAL	83.97	11.99	7	56	–	–	3079

ACCENT PIECE

15 X 7½ X 3⅛	79.66	11.75	7	105	–	–	2924
---------------------	-------	-------	---	-----	---	---	------



NOTES:





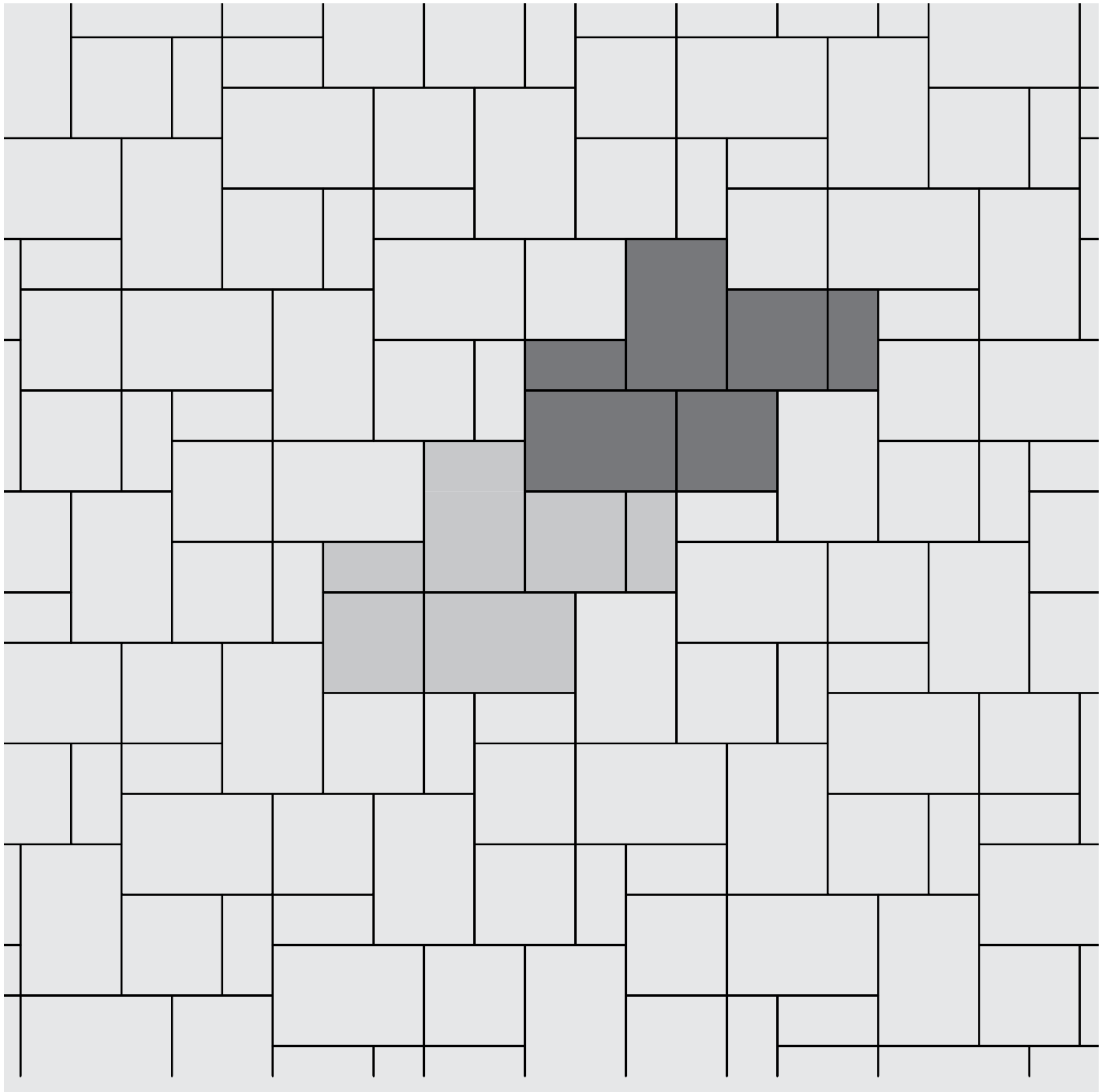

AutoCAD® hatch pattern files can be downloaded from belgard.com for use in architectural drawings.

Some patterns may not necessarily reflect the percentages of stone sizes within a particular pallet. In some cases you may have extras in one or more of the sizes. This must be accounted for in your planning and design.





Scan for additional
product information

PEDESTRIAN	LIGHT/REGULAR TRAFFIC	HEAVY TRAFFIC	PERMEABLE	ADA	DURAFUSION PROCESS	TRUECOLOR PROCESS
						
✓	✓*			✓	✓**	✓**

*Only applicable for Origins 6 and accents.

**Durafusion and Truecolor process varies by product color.

SHAPES & SIZES

Origins 6 - 3-Piece



3 x 6 x 2³/₈



6 x 6 x 2³/₈



6 x 9 x 2³/₈

Origins 12 - 3-Piece



6 x 12 x 2³/₈



12 x 12 x 2³/₈

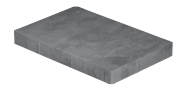

12 x 18 x 2³/₈

UNIT	SQFT/ PALLET	SQFT/ LAYER	LAYER/ PALLET	UNITS/ PALLET	UNITS/ LAYER	UNITS/ SQFT	WEIGHT/ PALLET	LNFT/PALLET (SOLDIER)	LNFT/PALLET (SAILOR)
------	-----------------	----------------	------------------	------------------	-----------------	----------------	-------------------	--------------------------	-------------------------

ORIGINS 6 - 3-PIECE

3 X 6 X 2 ³ / ₈	120	12	10	480	48	-	3325	160	240
6 X 6 X 2 ³ / ₈									
6 X 9 X 2 ³ / ₈									

ORIGINS 12 - 3-PIECE

6 X 12 X 2 ³ / ₈	120	12	10	120	12	-	3516	-	120
12 X 12 X 2 ³ / ₈									
18 X 12 X 2 ³ / ₈									



NOTES:

AutoCAD® hatch pattern files can be downloaded from belgard.com for use in architectural drawings.





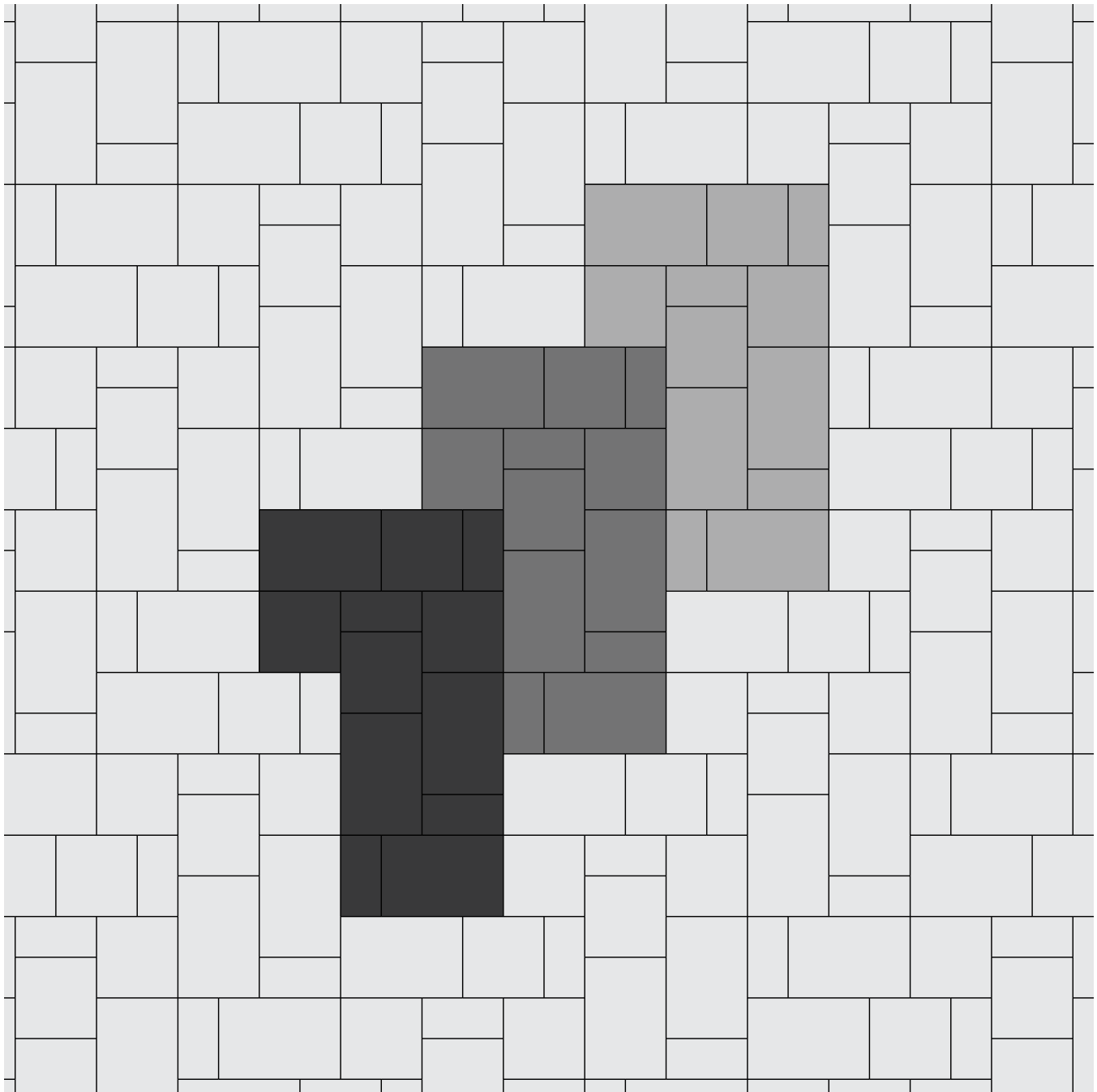

Some patterns may not necessarily reflect the percentages of stone sizes within a particular pallet. In some cases you may have extras in one or more of the sizes. This must be accounted for in your planning and design.

Percentages are based on area by paver.





Scan for additional
product information

PEDESTRIAN	LIGHT/REGULAR TRAFFIC	HEAVY TRAFFIC	PERMEABLE	ADA	DURAFUSION PROCESS	TRUECOLOR PROCESS
						
✓				✓	✓*	✓*

*Durafusion and Truecolor process varies by product color.

SHAPES & SIZES

3-Piece



9 x 18 x 2³/₈



18 x 18 x 2³/₈



18 x 27 x 2³/₈

UNIT	SQFT/ PALLET	SQFT/ LAYER	LAYER/ PALLET	UNITS/ PALLET	UNITS/ LAYER	UNITS/ SQFT	WEIGHT/ PALLET	LNFT/PALLET (SOLDIER)	LNFT/PALLET (SAILOR)
------	-----------------	----------------	------------------	------------------	-----------------	----------------	-------------------	--------------------------	-------------------------

3-PIECE

9 X 18 X 2 ³ / ₈ 18 X 18 X 2 ³ / ₈ 27 X 18 X 2 ³ / ₈	112.5	11.3	10	50	5	–	3152	–	–
--	-------	------	----	----	---	---	------	---	---



NOTES:

AutoCAD® hatch pattern files can be downloaded from belgard.com for use in architectural drawings.

Some patterns may not necessarily reflect the percentages of stone sizes within a particular pallet. In some cases you may have extras in one or more of the sizes. This must be accounted for in your planning and design.

Percentages are based on area by paver.

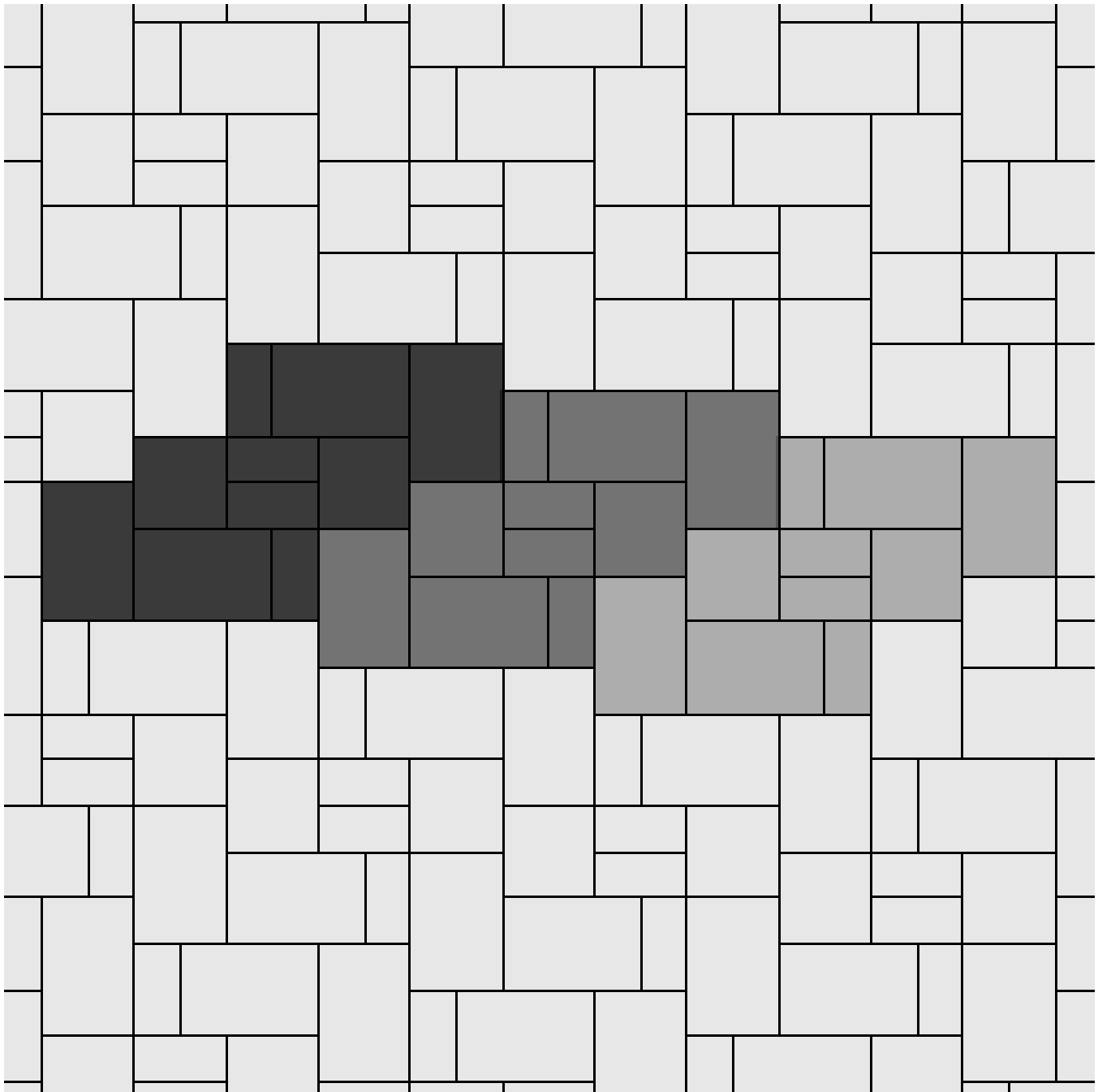



NOTES:

AutoCAD® hatch pattern files can be downloaded from belgard.com for use in architectural drawings.

Some patterns may not necessarily reflect the percentages of stone sizes within a particular pallet. In some cases you may have extras in one or more of the sizes. This must be accounted for in your planning and design.

Percentages are based on area by paver.

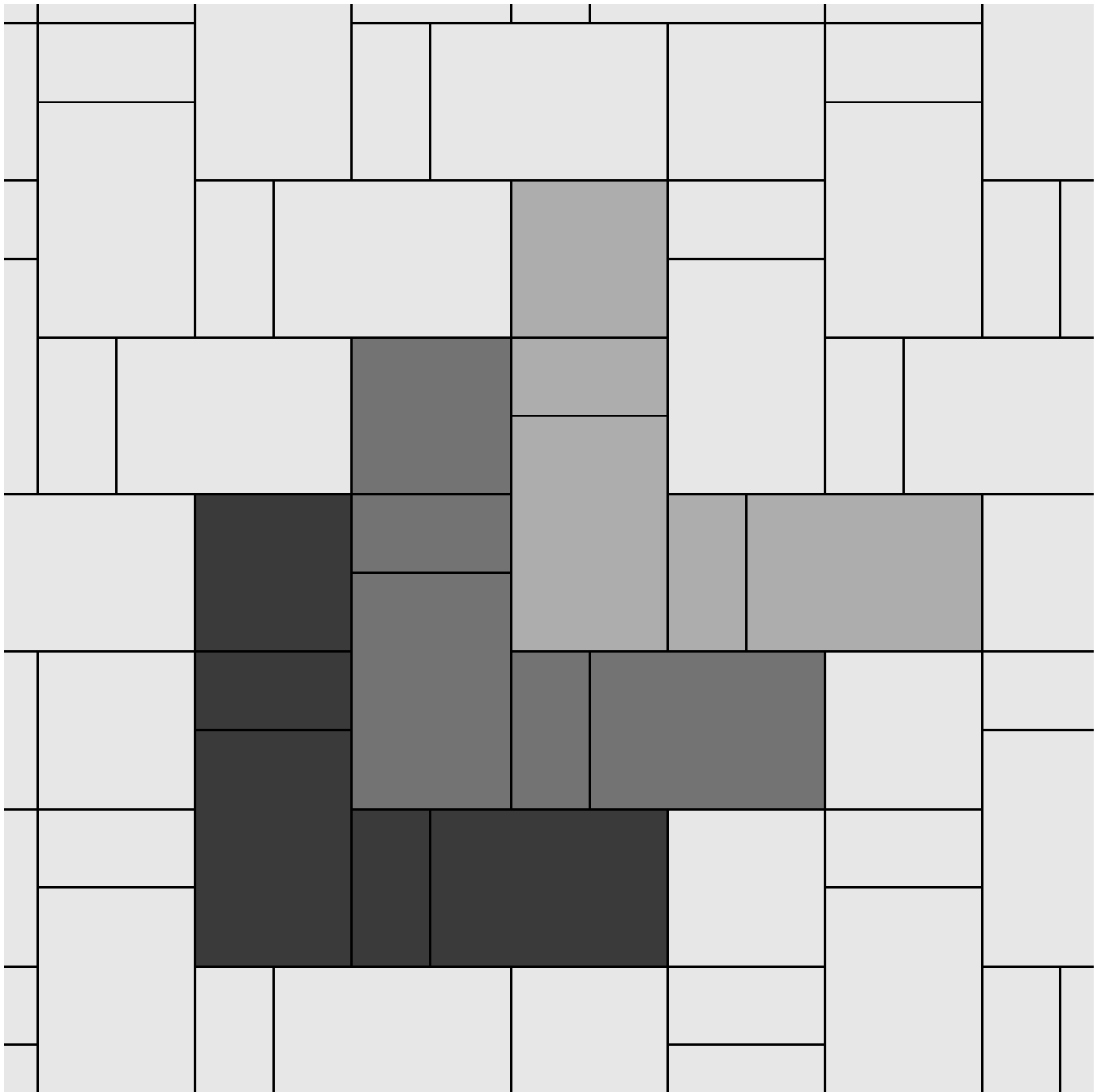

PERMEABLE PAVERS

PERMEABLE PAVER INSTALLATION GUIDE

39 Basic PICP Systems

PERMEABLE PAVERS

40 Aqua Roc™ I & II

43 Turfstone

45 Urbana® Stone

For basic paver installation information
visit icpi.org





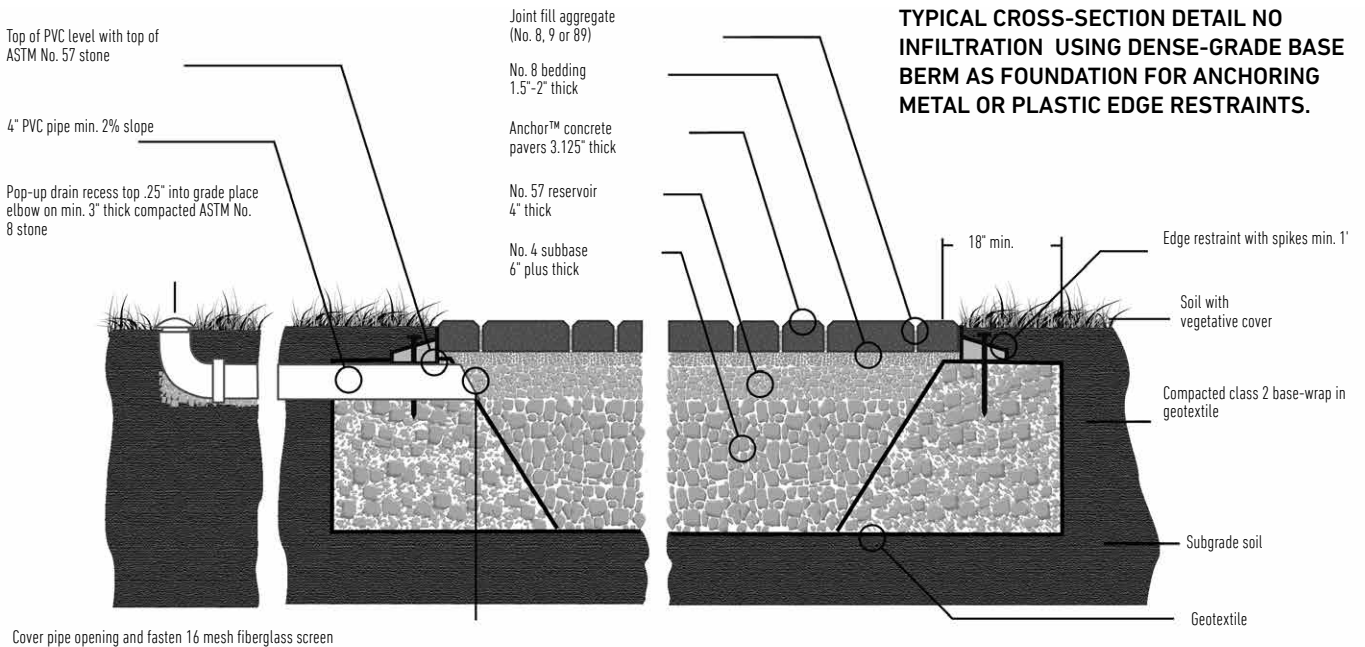
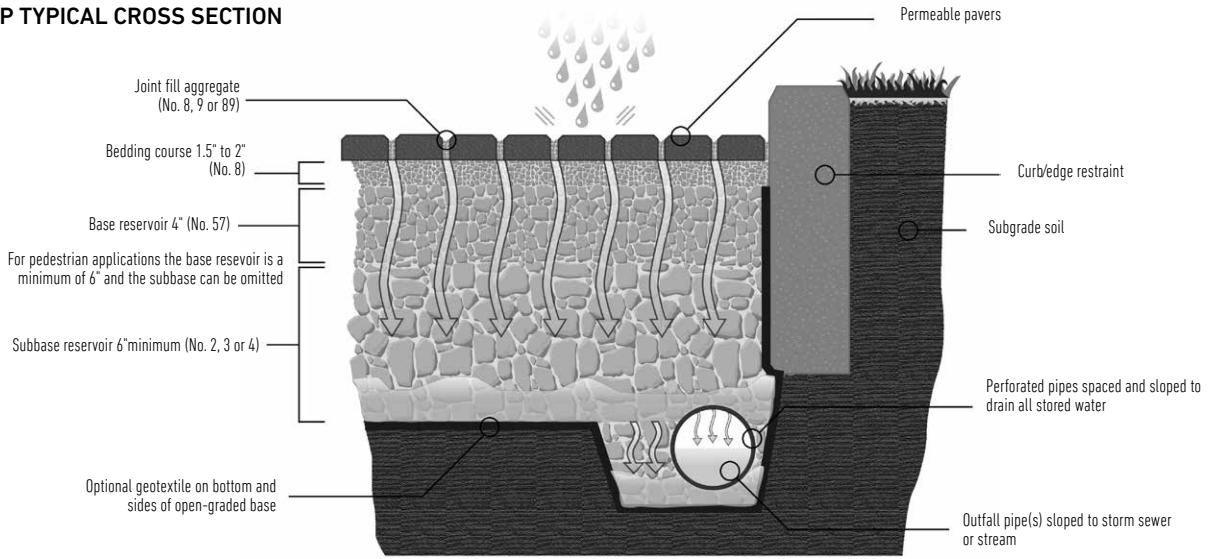

PERMEABLE INTERLOCKING CONCRETE PAVEMENT (PICP)

PICP TYPICAL CROSS SECTION





Scan for additional
product information

PEDESTRIAN	LIGHT/REGULAR TRAFFIC	HEAVY TRAFFIC	PERMEABLE	ADA	TEXTUREGUARD PROCESS	TRUECOLOR PROCESS
						
✓	✓	✓	✓	✓		✓

SHAPES & SIZES

Aqua Roc I

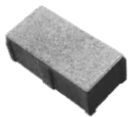

4½ x 9 x 3⅛

Aqua Roc II*

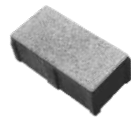

4 x 8 x 3⅛



*Available for
Mechanical Installation

UNIT	SQFT/ PALLET	SQFT/ LAYER	LAYER/ PALLET	UNITS/ PALLET	UNITS/ LAYER	UNITS/ SQFT	WEIGHT/ PALLET	LNFT/PALLET (SOLDIER)	LNFT/PALLET (SAILOR)
Aqua Roc I									
4½ X 9 X 3⅛	90	11.25	8	320	40	–	2880	120	240
Aqua Roc II*									
4 X 8 X 3⅛	92	10	–	–	–	–	2944	–	–



NOTES:

AutoCAD® hatch pattern files can be downloaded from belgard.com for use in architectural drawings.

Some patterns may not necessarily reflect the percentages of stone sizes within a particular pallet. In some cases you may have extras in one or more of the sizes. This must be accounted for in your planning and design.



*Available for Mechanical Installation

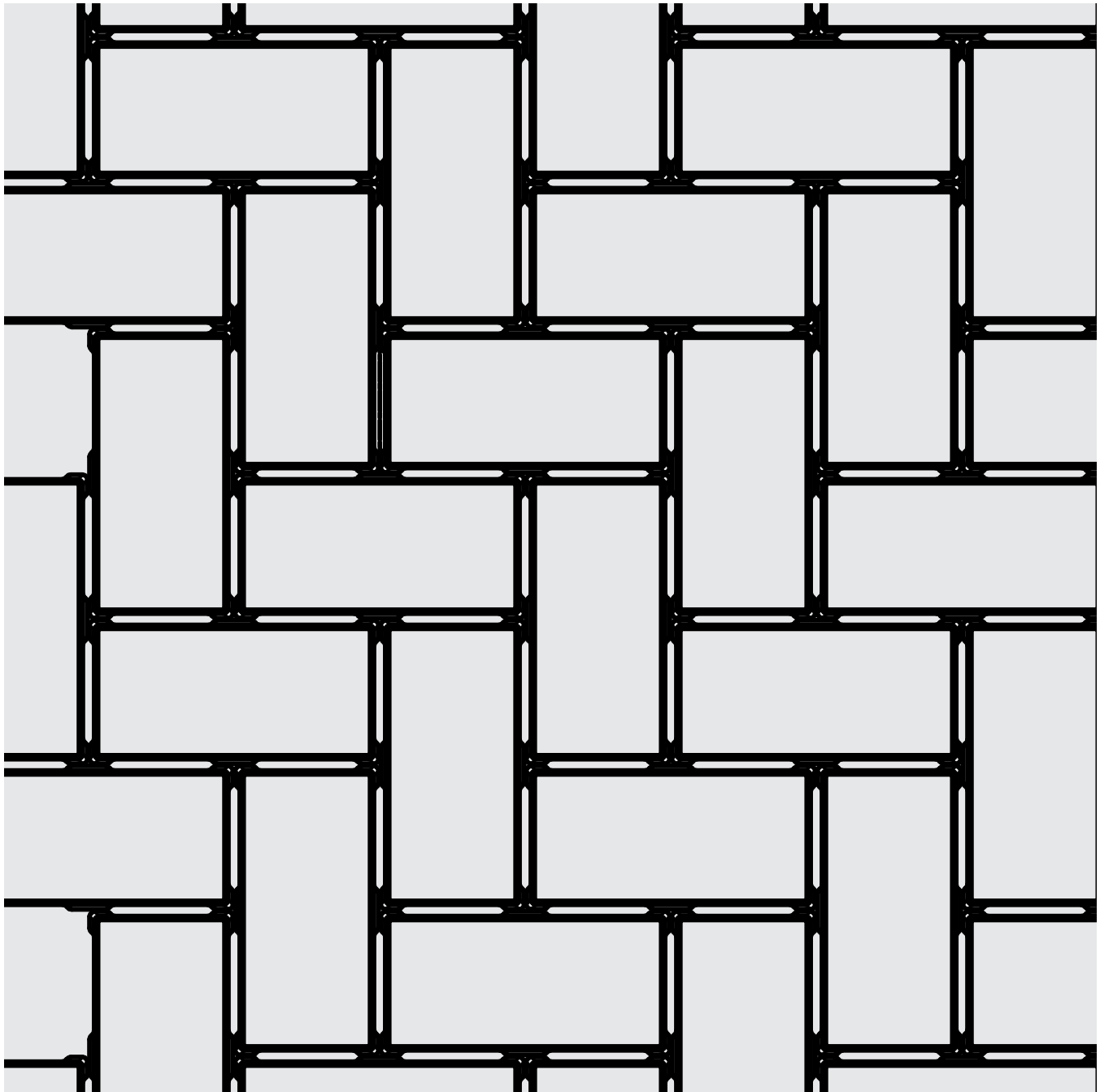



NOTES:

AutoCAD® hatch pattern files can be downloaded from belgard.com for use in architectural drawings.

Some patterns may not necessarily reflect the percentages of stone sizes within a particular pallet. In some cases you may have extras in one or more of the sizes. This must be accounted for in your planning and design.

1-PIECE RUNNING BOND PATTERN

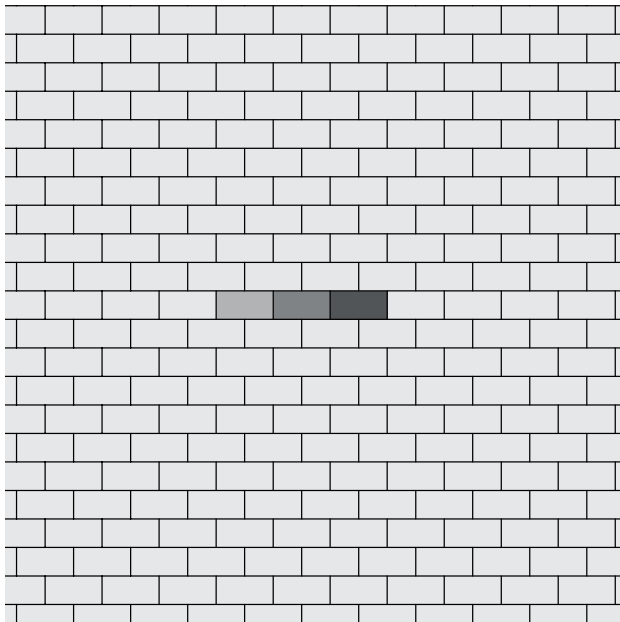

1-PIECE HERRINGBONE PATTERN

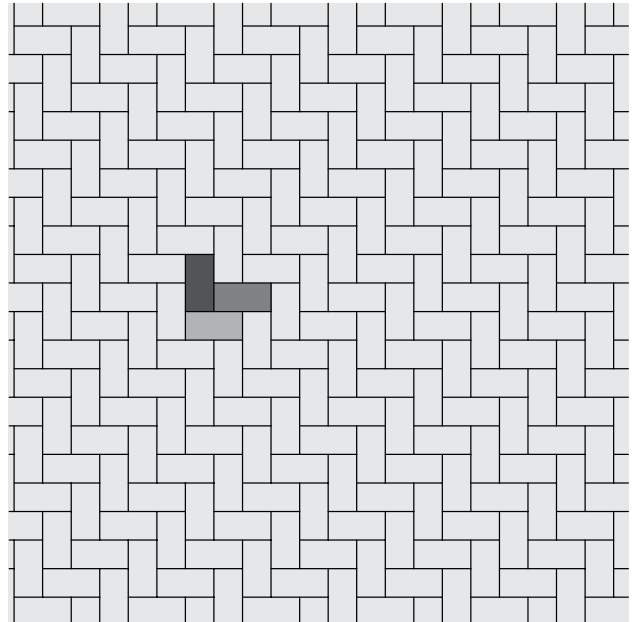



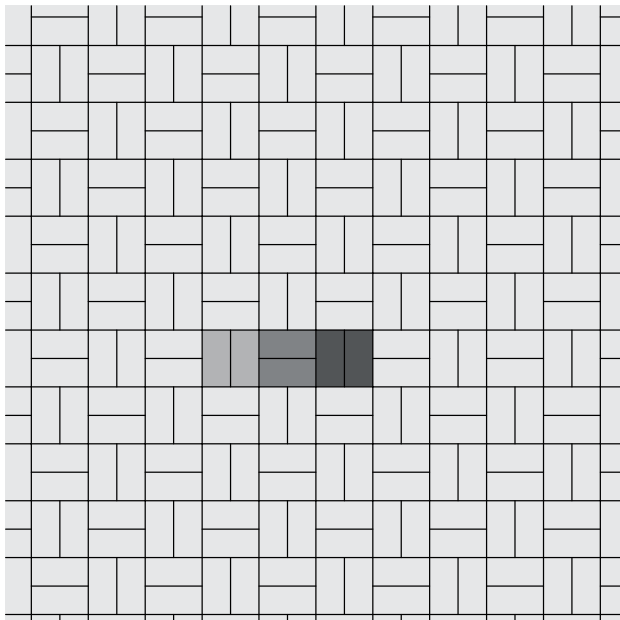



1-PIECE BASKET WEAVE PATTERN





Scan for additional
product information

PEDESTRIAN	LIGHT/REGULAR TRAFFIC	HEAVY TRAFFIC	PERMEABLE	ADA	DURAFUSION PROCESS
					
✓	✓		✓		

SHAPES & SIZES

80mm

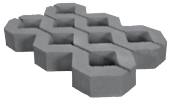

15³/₄ x 23⁵/₈ x 3¹/₈

UNIT	SQFT/ PALLET	SQFT/ LAYER	LAYER/ PALLET	UNITS/ PALLET	UNITS/ LAYER	UNITS/ SQFT	WEIGHT/ PALLET	LNFT/PALLET (SOLDIER)	LNFT/PALLET (SAILOR)
80MM									
15 ³ / ₄ X 23 ⁵ / ₈ X 3 ¹ / ₈	103.2	12.9	8	40	5	2.58	2377	52.5	78.75



NOTES:

AutoCAD® hatch pattern files can be downloaded from belgard.com for use in architectural drawings





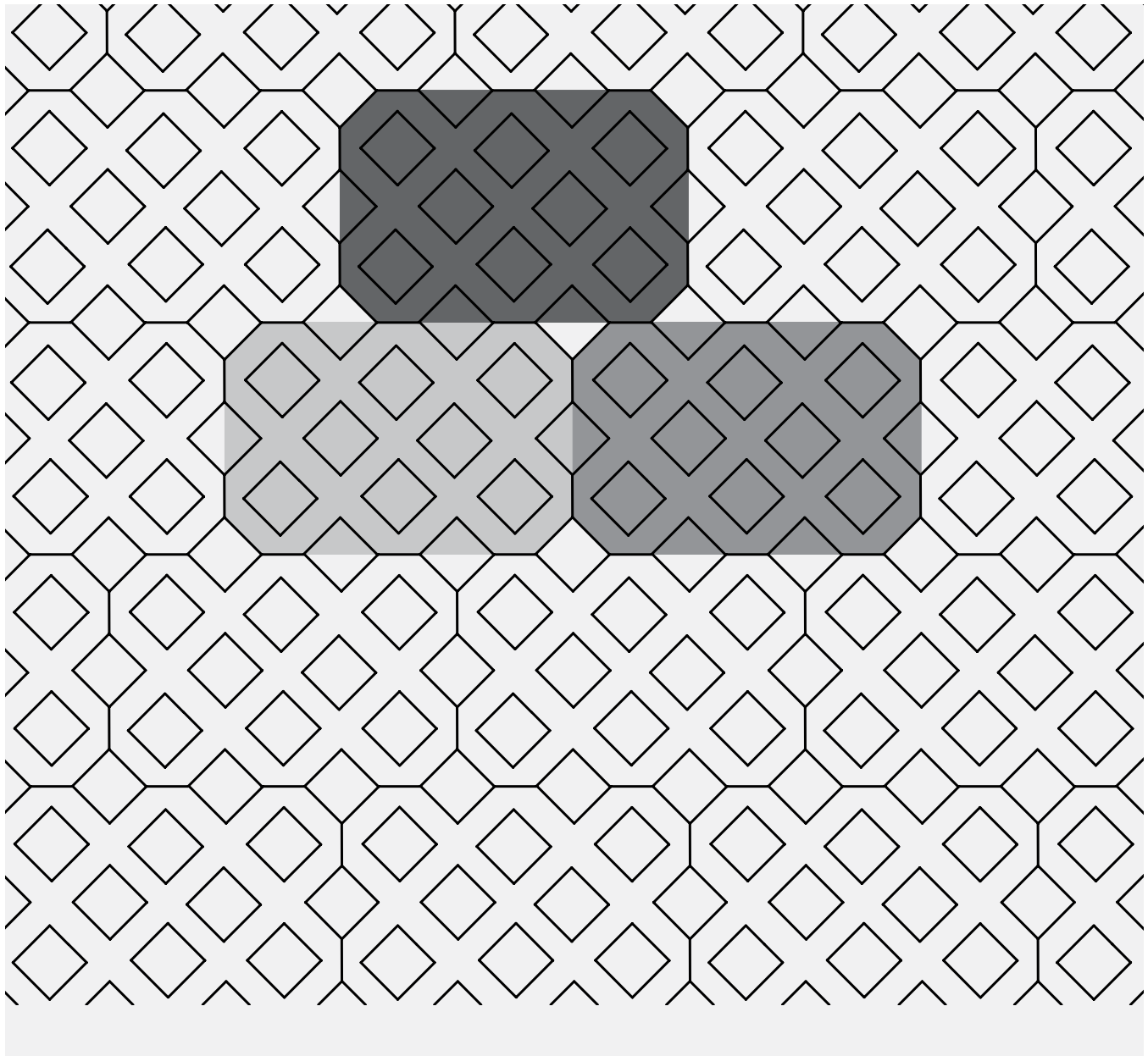

Some patterns may not necessarily reflect the percentages of stone sizes within a particular pallet. In some cases you may have extras in one or more of the sizes. This must be accounted for in your planning and design.

100% 15³/₄ x 23⁵/₈ Units





Scan for additional
product information

PEDESTRIAN	LIGHT/REGULAR TRAFFIC	HEAVY TRAFFIC	PERMEABLE	ADA	TRUECOLOR PROCESS
					
✓	✓		✓		✓

SHAPES & SIZES

3-piece Modular 60mm



8 x 4 x 2³/₈



8 x 8 x 2³/₈



8 x 12 x 2³/₈

UNIT	SQFT/ PALLET	SQFT/ LAYER	LAYER/ PALLET	UNITS/ PALLET	UNITS/ LAYER	UNITS/ SQFT	WEIGHT/ PALLET
------	-----------------	----------------	------------------	------------------	-----------------	----------------	-------------------

3-PIECE MODULAR 60mm

8 X 4 X 2 ³ / ₈							
8 X 8 X 2 ³ / ₈	116.4	11.625	10	216	-	-	3419
8 X 12 X 2 ³ / ₈							



NOTES:

AutoCAD® hatch pattern files can be downloaded from belgard.com for use in architectural drawings

Some patterns may not necessarily reflect the percentages of stone sizes within a particular pallet. In some cases you may have extras in one or more of the sizes. This must be accounted for in your planning and design.

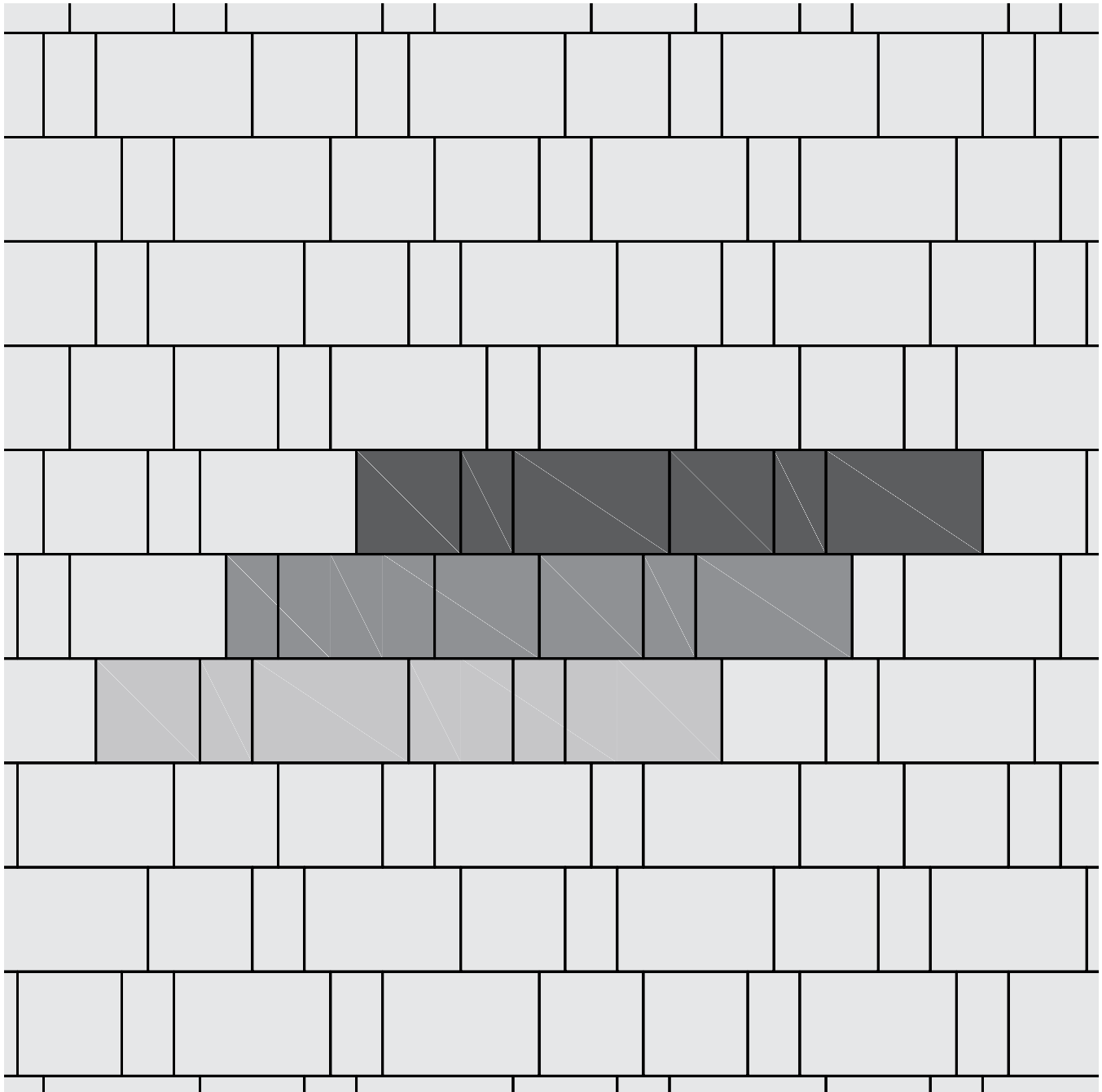

PORCELAIN PAVERS & PLANKS

PORCELAIN INSTALLATION GUIDE

- 48 Porcelain Paver Advantages
- 48 Specialty Tools for Porcelain Pavers Construction
- 49 Cleaning & Maintenance For Porcelain Products
- 49 Porcelain Paver Installation
- 50 Sand Set over Compacted Road Base Installation (Pedestrian Foot Traffic)
- 50 Sand Set over Concrete Overlay Installation (Pedestrian Foot Traffic)
- 51 Gravel Set over Open Graded Aggregate Installation
- 52 Cementitious Adhesive Overlay, Concrete Base Installation (Light Vehicular Traffic)

PORCELAIN PAVERS & PLANKS

- | | | | |
|----|-------------|----|--------------|
| 53 | Foundation™ | 57 | Quarziti 2.0 |
| 54 | Genoa™ | 58 | Unico Coping |
| 55 | Glocal | 59 | Verona™ |
| 56 | Noon | | |

For basic paver installation information
visit icpi.org

PORCELAIN PAVERS

Belgard Porcelain Pavers are formed by pressing, followed by vitrification: this process involves the total fusion into a single material made from natural raw materials (sand, quartz, feldspars, kaolin, clays and inorganic pigments) which, fired at temperatures above 1226.67° C (2240° F), are transformed into a product with exceptional hardness, ultra-low absorption rate and unmatched mechanical characteristics. Belgard porcelain pavers are eco-compatible and ecolabel-certified. Each unit is 20mm (0.7874") standard thickness or ¾" nominal thickness and is durable enough to withstand use in exterior applications.

PORCELAIN PAVERS ADVANTAGES:

- **Freeze thaw resistant**—They are 100% frost-free and their properties remain unaltered at temperatures ranging from -51.1° to + 60° C (-60° F to +140°F).
- **Color durability**—Color is fused by vitrification, becomes an integral part of the porcelain surface and is not affected by elements.
- **Easy installation**—Perfect fit and for fast installs.
- **Low absorption rate**—Spills, salt and other materials will not seep into pours.
- **Easy to clean**—Household cleaners can be used to wipe down spills and dirt; can even be pressure washed with a low pressure washing device* (see pressure washing warning below).*
- **Stylish**—Matches what homeowners are currently doing inside the home.
- **Durable**—High breakage loads of up to 3,587 lbs (1,627 kg) per foot based on ASTM-C648.
- **Resistant**— High compressive strength and ultra-low absorption rate creates a dense surface that resists mold, moss, dirt and other staining.
- **Skid-resistant**—Structured paver top textures create slip resistant surfaces for safety; perfect for around pools/spas or in wet climates.
- **Modular Design**—Superior accuracy in dimensional sizing and linear sides, the slabs allow for perfectly executed installations with tight and accurate lines.
- **Light weight**—16.8 kg (37 lbs) for the 24"x24" paver permit for easy installation, removal and serviceability and even reusability (Excluding adhered installations).
- Available in colors that have an SRI that qualifies for a LEED certification. The SRI on some units ranges between 60-80. To receive LEED credit, the SRI must be at least 29.
- **Impermeable**— Deicing salt and other deicing materials can be used without concern of damage.

* It is important that all pressure washing of your porcelain pavers be done with a low pressure washer with a maximum of 1600 psi and nothing more powerful. When pressure washing your installation, care should be taken to prevent damage to the grout (adhesive and grout installations) and some re-sanding will be necessary when power washing an installation with sand or polymeric sand joints.

SPECIALTY TOOLS FOR PORCELAIN PAVER CONSTRUCTION:

- Wet cut tile saw equipped with a diamond blade manufactured for wet cutting porcelain. The saw should be designed to safely cut a 24 inch length porcelain paver.
- A paver clamp for easy handling, which can be used to both install and remove pavers.
- The use of gloves is highly recommended while handling and installing porcelain slabs.
- Appropriate notched trowels and grout float tools for cementitious adhesive and grout installation. The appropriate tool selection would be based on the adhesive and grout manufacturer's recommendation
- Pallets of porcelain pavers are manufactured and shipped with a Heavy Duty plastic protective pallet cover and the individual porcelain pavers are packaged in protective cardboard boxes. To prevent damage to your pavers, do not remove the protective cardboard boxes until you are ready to install them.
- Caution: Removing pavers from their protective packaging and handling multiple loose stones together creates the possibility for chipping.

Once the Heavy Duty plastic pallet covers have been removed from the pallet, the unused boxed pavers should be protected from the elements to insure the integrity of the protective cardboard boxes.

CLEANING & MAINTENANCE FOR PORCELAIN PRODUCTS

Post-laying cleaning is obligatory after on site works. Inadequate or late removal of the grouting used on the joints can leave marks difficult to remove and create, on the flooring, a cement film able to absorb all types of dirt, thus giving the impression that it is the material that has become dirty.

It is indispensable to dissolve and remove these residues completely using buffered acids diluted in water (follow the instructions on the packs of the products used), which must then be removed completely and quickly, rinsing the floor with plenty of water to avoid residues or drops on the floor which could damage the tiles.

Allow the product to act on the wet floor, without letting it dry and rubbing it with colorless rags. Next, rinse it thoroughly with water to ensure that the floor is free of detergent residues. If necessary, repeat the operation.

We suggest performing a preliminary wash on a sample surface of a few square meters; if the test is successful, extend clearing over the entire surface. When you have done the above wash, carry out a basic or alkaline wash using degreasing detergents. This is because acid can leave grease on the floor, which could contribute to retaining dirt.

PORCELAIN PAVER INSTALLATION

Each of the following option details will include specific information relative to the selected installation. Base thicknesses vary between different geographical and climatic locations and the contractor will be installing typical base thicknesses for paving installations in their location.

Installing porcelain pavers requires the bedding course sand to be pre-compacted and then struck off with a screed to the required thickness as shown in the detail drawings. The porcelain pavers are not compacted and therefore the sand layer beneath them requires pre-compaction. Do not compact dry sand, but insure the sand has a 5 to 6% moisture content so that it will compact cohesively and allow for a smooth strike off finish.

INSTALLATION INFORMATION THAT MUST BE FOLLOWED :

- Weather, soil type and job conditions should be considered when choosing the best installation method.
- When installing porcelain planks (12 x 48, 8 x 48) always lay the pattern of the 1/3s. These should not be placed next to each other at 50%
- NEVER compact porcelain pavers with a plate compactor. Roller compactor recommended for all compaction with porcelain products
- ALWAYS pre-compact and strike off your sand leveling course before installing your porcelain pavers in sand set installations.
- A proper surface drainage system is required to mitigate standing water. Please consider that Belgard Porcelain Paves are impervious, therefore water must be properly discharged and drained away from the pavement.
- Porcelain pavers should only be wet cut with a tile saw equipped with a wet cut porcelain blade.
- NEVER install porcelain pavers without the required 4mm spacing between them. The porcelain pavers should never be installed with a porcelain to porcelain contact. Plastic 4mm spacers (shown at right) should be used on Sand Set and Permeable installations. The photo on the left illustrates the spacer installed in a perspective to support and space 4 paver corners and the photo on the right illustrates the installed spacer snapped apart (as designed) to form Space T that supports 2 paver corners. This versatility will permit your porcelain pavers to be installed in a stack bond pattern, a running bond patterns as well as a flush installation against another structure.
- For a 100 sf. project, approximately 34 spacers are needed; this allows for overages if needed.

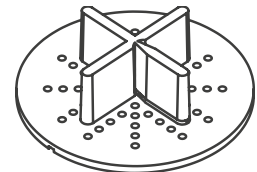

4mm spacers

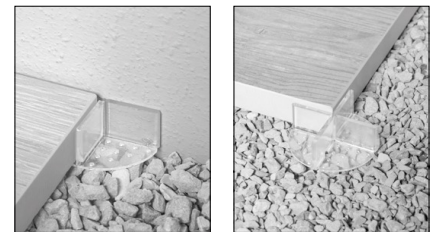

SAND SET OVER COMPACTED ROAD BASE INSTALLATION (PEDESTRIAN FOOT TRAFFIC)

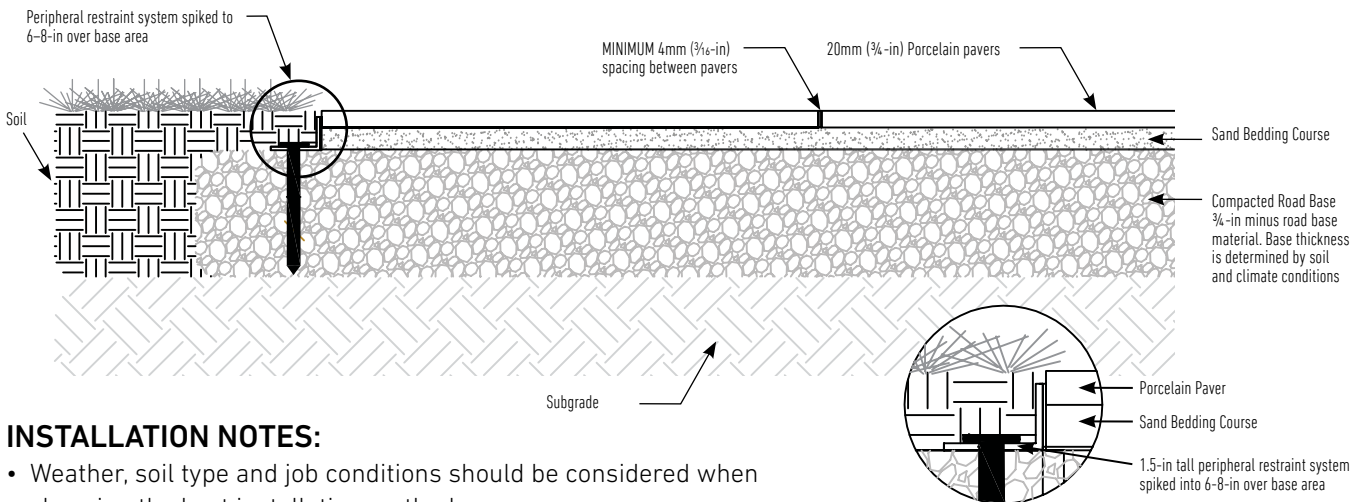

INSTALLATION NOTES:

- Weather, soil type and job conditions should be considered when choosing the best installation method.
- Follow the detailed drawing above
- Base material is to be over based 6 to 8 inches beyond the edge of the pavement.
- Precompact the sand bedding course and screed to 1-in thickness with smooth surface
- The required edge restraint system is a low profile edge restraint with a vertical height of 1 1/2-in as shown in the drawing.
- Insure that pavement is constructed with a 1 1/2 to 2% slope that it is pitched away from any building.
- Insure the plastic 4mm spacers are installed at all corners of the installed pavers

SAND SET OVER CONCRETE OVERLAY INSTALLATION (PEDESTRIAN FOOT TRAFFIC)

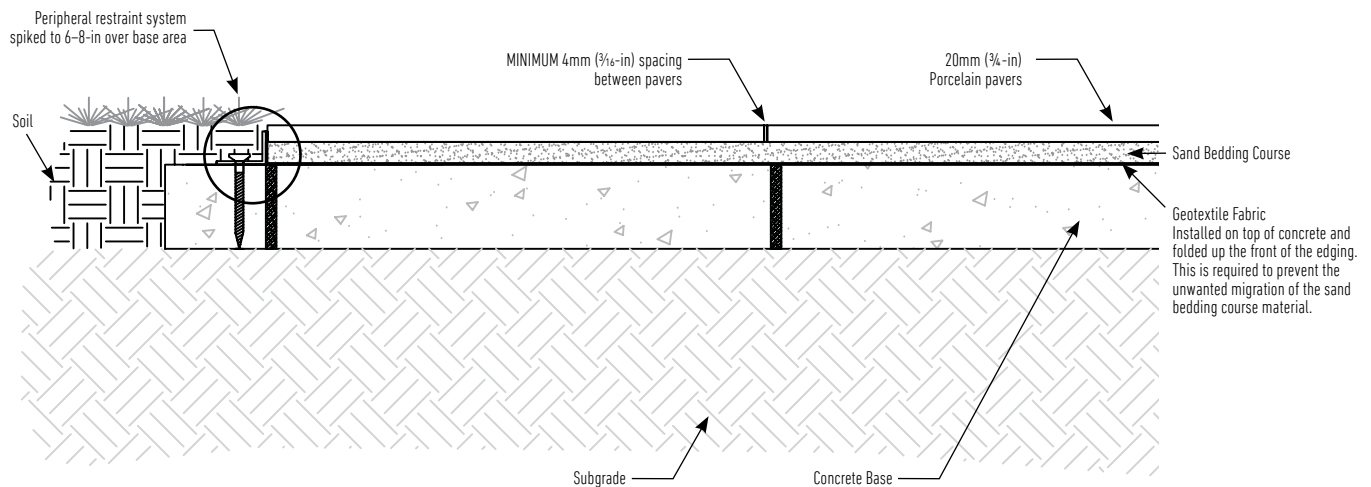

INSTALLATION NOTES:

- Weather, soil type and job conditions should be considered when choosing the best installation method.
- A concrete curve with a full depth and finished height is needed to ensure full containment of the bedding sand and the Belgard Porcelain Pavers.
- Precompact the sand bedding course and screed to 1-in thickness with smooth surface
- Mechanically anchor edge restraint into the concrete base.
- Insure geotextile is installed directly on top of the concrete to contain the bedding sand.
- Insure that pavement is constructed with a 1 1/2 to 2 percent slope and that it is pitched away from any building.
- Insure the plastic 4mm spacers are installed at all corners of the installed pavers.

GRAVEL SET OVER OPEN GRADED AGGREGATE INSTALLATION

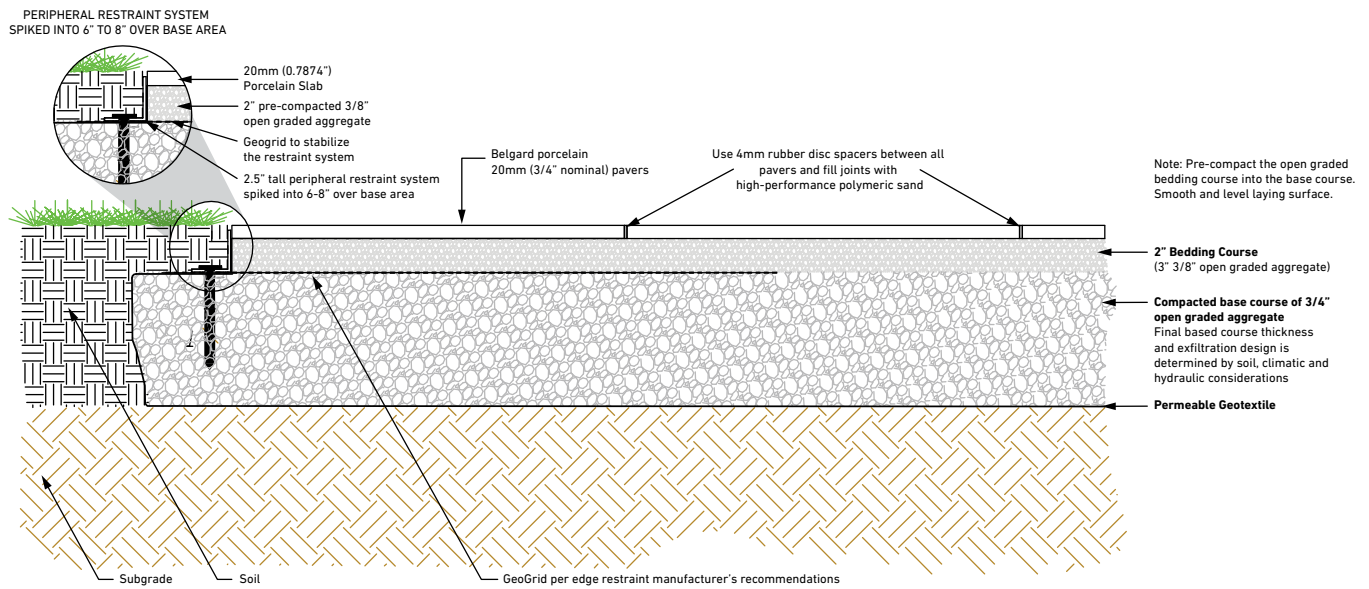

INSTALLATION NOTES:

- Weather, soil type and job conditions should be considered when choosing the best installation method. Follow the detail drawing.
- The required edge restraint system for this installation has a vertical height of 2½ inches as shown in the drawing. Follow the edge restraint manufacturer's recommendations for the use of their product in permeable applications regarding geogrid usage and placement to maintain the performance of there edging.
- Ensure that pavement is constructed with a 2% slope and that it is pitched away from any building.
- Ensure the 4mm spacers are installed between all pavers.
- The open-graded aggregate should be clean and free from foreign matter, manufactured from crushed rock and conform to ASTM C33 size No. 57. Do not use recycled aggregates or rounded river gravel.
- Additional Drainage: If the project has fine-grained soils, silts or clays, and contributing water sources such as downspouts or groundwater, it is important to install a perforated pipe underdrain to prevent saturation of the subgrade. Make sure underdrain has an acceptable discharge location.
- When installing porcelain planks (12 x 48 & 8 x 48), always lay the pattern of 1/3's. These should not be placed next to each other at 50%.
- compaction
- Roller Compactor recommended for all compaction with Porcelain products

CEMENTITIOUS ADHESIVE OVERLAY, CONCRETE BASE INSTALLATION (LIGHT VEHICULAR TRAFFIC)

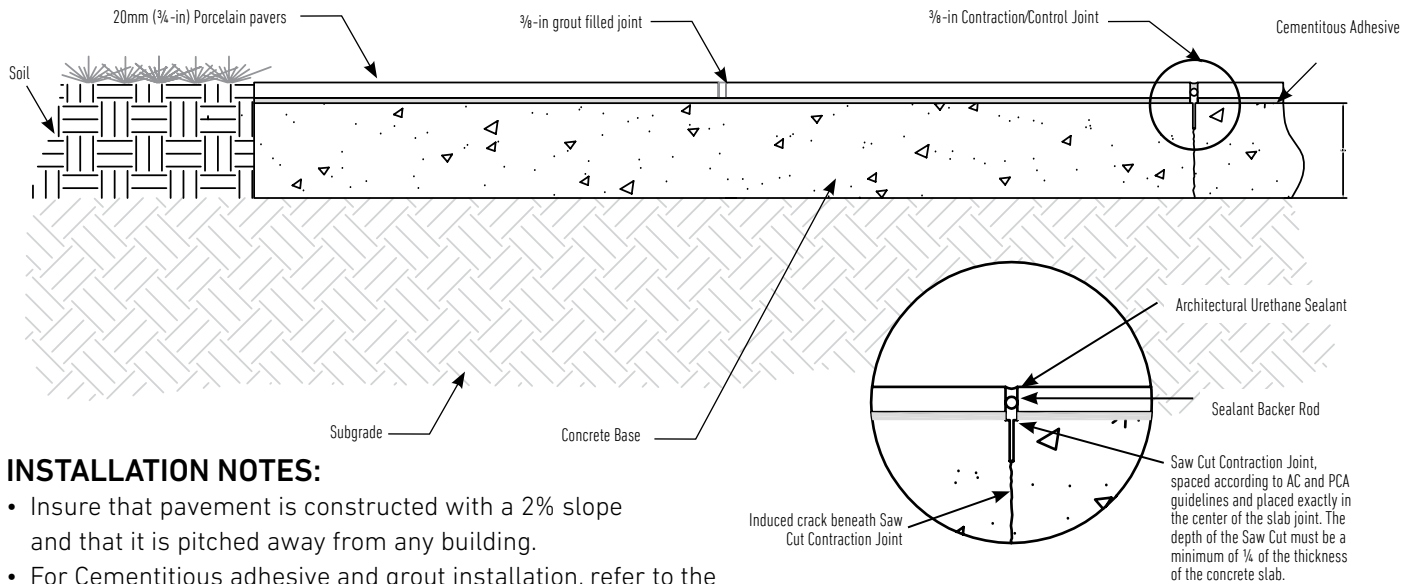

INSTALLATION NOTES:





- Insure that pavement is constructed with a 2% slope and that it is pitched away from any building.
- For Cementitious adhesive and grout installation, refer to the manufacturer's technical instructions and specifically as they relate to outdoor installations.
- For concrete foundation slabs that are not large enough to require contraction / control joints, a minimum 4mm (1/8" to 3/16") grout joint is acceptable, but for larger concrete foundation slabs that do require contraction / control joints, the joint width should be a 3/8". It is absolutely imperative that all contraction / control joints be located in the joint line of installed porcelain pavers and not beneath a paver.
- Caution: If a Porcelain Paver is installed over a control joint, the paver will reflectively crack along the contraction / control joint beneath it.

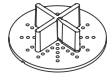

Scan for additional
product information



Spacers are recommended for all porcelain paver installations.
PLEASE NOTE: For vehicular applications, must be a mortar install over a concrete slab.
Please refer to the Porcelain install guide for driveway install procedure.

PEDESTRIAN	LIGHT/REGULAR TRAFFIC	HEAVY TRAFFIC	PERMEABLE	ADA
				
✓				✓

SHAPES & SIZES

24 x 24



23.54 x 23.54 x 3/4





UNIT	GROSS WEIGHT/ BOX	PIECES/ BOX	SQFT/ BOX	BOXES/ PALLET	SQFT/ PALLET	GROSS WEIGHT/ PALLET
24 X 24						
23.54 X 23.54 X 3/4	67.84	2	7.64	36	275.04	2533.80

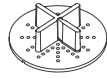

Scan for additional product information



Spacers are recommended for all porcelain paver installations.
PLEASE NOTE: For vehicular applications, must be a mortar install over a concrete slab.
Please refer to the Porcelain install guide for driveway install procedure.

PEDESTRIAN	LIGHT/REGULAR TRAFFIC	HEAVY TRAFFIC	PERMEABLE	ADA
				
✓				✓

SHAPES & SIZES

24 x 24



23.54 x 23.54 x 3/4

12 x 24

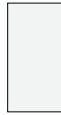

11.73 x 23.54 x 3/4





UNIT	GROSS WEIGHT/ BOX	PIECES/ BOX	SQFT/ BOX	BOXES/ PALLET	SQFT/ PALLET	GROSS WEIGHT/ PALLET
24 X 24						
23.54 X 23.54 X 3/4	67.84	2	7.64	36	275.04	2533.80
12 X 24						
11.73 X 23.54 X 3/4	68.23	4	7.59	40	303.6	2807

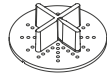

Scan for additional product information



Spacers are recommended for all porcelain paver installations.
PLEASE NOTE: For vehicular applications, must be a mortar install over a concrete slab.
Please refer to the Porcelain install guide for driveway install procedure.

PEDESTRIAN	LIGHT/REGULAR TRAFFIC	HEAVY TRAFFIC	PERMEABLE	ADA
				
✓				✓

SHAPES & SIZES

24 x 24



23.54 x 23.54 x 3/4

24 x 48

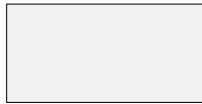

23.54 x 47.17 x 3/4

Unico

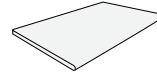

12.99 x 23.54 x 3/4

*Special Order Only

36 x 36*



35.35 x 35.35

36 x 36 Not Available in Clear

48 x 48*



47.17 x 47.17

MIRAGE[®]
Porcelain. Design. Sustainability





UNIT	GROSS WEIGHT/ BOX	PIECES/ BOX	SQ FT/ BOX	BOXES/ PALLET	SQ FT/ PALLET	GROSS WEIGHT/ PALLET
24 X 24						
23.54 X 23.54 X 3/4	72	2	7.75	30	232.5	2160
24 X 48						
23.54 X 47.17 X 3/4	74	1	7.75	35	271.25	2621
UNICO						
12.99 X 23.54 X 3/4	52	3	6	40	240	2080
36 X 36						
35.35 X 35.35	–	–	–	–	–	–
48 X 48						
47.17 X 47.17	–	–	–	–	–	–

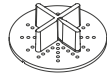

Scan for additional product information



Spacers are recommended for all porcelain paver installations.
PLEASE NOTE: For vehicular applications, must be a mortar install over a concrete slab.
Please refer to the Porcelain install guide for driveway install procedure.

PEDESTRIAN	LIGHT/REGULAR TRAFFIC	HEAVY TRAFFIC	PERMEABLE	ADA
				
✓				✓

SHAPES & SIZES

8 x 48



7.64 x 47.17 x 3/4

12 x 48



11.73 x 47.17 x 3/4

Unico

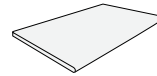

12.99 x 23.54 x 3/4

UNIT	GROSS WEIGHT/ BOX	PIECES/ BOX	SQFT/ BOX	BOXES/ PALLET	SQFT/ PALLET	GROSS WEIGHT/ PALLET
8 X 48						
7.64 X 47.17 X 3/4	46	2	5.06	30	151.8	1380
12 X 48						
11.73 X 47.17 X 3/4	74	2	7.75	36	279	2664
UNICO						
12.99 X 23.54 X 3/4	52	3	6	40	240	2080

QUARZITI 2.0





PORCELAIN COLLECTION 

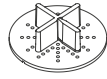

Scan for additional product information



Spacers are recommended for all porcelain paver installations.
PLEASE NOTE: For vehicular applications, must be a mortar install over a concrete slab.
Please refer to the Porcelain install guide for driveway install procedure.

PEDESTRIAN	LIGHT/REGULAR TRAFFIC	HEAVY TRAFFIC	PERMEABLE	ADA
				
✓				✓

SHAPES & SIZES

24 x 24



23.54 x 23.54 x 3/4

24 x 48



23.54 x 47.17 x 3/4

Unico

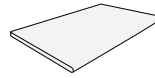

12.99 x 23.54 x 3/4

UNIT	GROSS WEIGHT/ BOX	PIECES/ BOX	SQFT/ BOX	BOXES/ PALLET	SQFT/ PALLET	GROSS WEIGHT/ PALLET
------	-------------------	-------------	-----------	---------------	--------------	----------------------

24 X 24

23.54 X 23.54 X 3/4	72	2	7.75	30	232.5	2160
---------------------	----	---	------	----	-------	------

24 X 48

23.54 X 47.17 X 3/4	74	1	7.75	35	271.25	2621
---------------------	----	---	------	----	--------	------

MIRAGE[®]
Porcelain.Design.Sustainability

UNICO COPING





PORCELAIN COLLECTION 

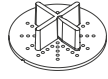

Scan for additional product information



Spacers are recommended for all porcelain paver installations.
PLEASE NOTE: For vehicular applications, must be a mortar install over a concrete slab.
Please refer to the Porcelain install guide for driveway install procedure.

RESIDENTIAL	COMMERCIAL	STEPS	CAPS	COPING
				
✓		✓		✓

SHAPES & SIZES

Unico

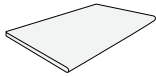

12.99 x 23.54 x 3/4"

UNIT	GROSS WEIGHT/ BOX	PIECES/ BOX	LN FT/ BOX	BOXES/ PALLET	LN FT/ PALLET	GROSS WEIGHT/ PALLET
UNICO						
12.99 X 23.54 X 3/4"	52	3	6	40	240	2080

Two installation needs, a single solution. UNICO, size 12.99"x 23.51"x 3/4", is processed on both sides, on one side it has a rounded edge and on the other a square edge.

An extremely versatile special piece, which can be used both as a step and as a special piece for swimming pools, with bullnose edge or straight edge, both colored along the side.

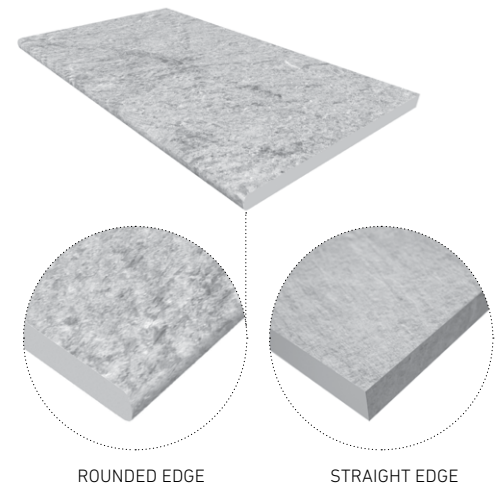

ROUNDED EDGE





STRAIGHT EDGE

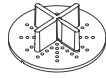

Scan for additional product information



Spacers are recommended for all porcelain paver installations.
PLEASE NOTE: For vehicular applications, must be a mortar install over a concrete slab.
Please refer to the Porcelain install guide for driveway install procedure.

PEDESTRIAN	LIGHT/REGULAR TRAFFIC	HEAVY TRAFFIC	PERMEABLE	ADA
				
✓				✓

SHAPES & SIZES

24 x 24



23.54 x 23.54 x 3/4

Unico*

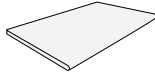

12.99 x 23.54 x 3/4

**Available in Blue Stone and Platinum Only*

UNIT	GROSS WEIGHT/ BOX	PIECES/ BOX	SQFT/ BOX	BOXES/ PALLET	SQFT/ PALLET	GROSS WEIGHT/ PALLET
24 X 24						
23.54 X 23.54 X 3/4	72	2	7.75	30	232.5	2160

WALLS

WALL INSTALLATION GUIDE

- 61 Wall Types
- 63 Before You Begin

WALLS

- 64 Brisa® Wall
- 66 Diamond® 9D
- 68 Diamond Pro® Straight Face
- 69 Melville™ Wall
- 70 Sterling® Wall
- 71 Ashlar Tandem™
- 71 Lamina Tandem
- 71 Melville Tandem™
- 73 Weston Stone™ 3-Piece & Universal

For basic wall installation information
visit ncma.org



*NCMA Segmental
Retaining Wall
Installation Guide*



*NCMA Segmental
Retaining Walls:
Residential Applications*

SEGMENTAL RETAINING WALL TYPES

Segmental retaining walls typically fall into one of three categories.

GRAVITY RETAINING WALL

The first category — a gravity wall — is a retaining wall that does not use soil reinforcement. A gravity wall has height limitations specific to each product. An advantage of this type of retaining wall is that it requires a smaller work area behind the wall.

A gravity wall relies on the weight and setback of the block to resist the soil forces being exerted on the wall.

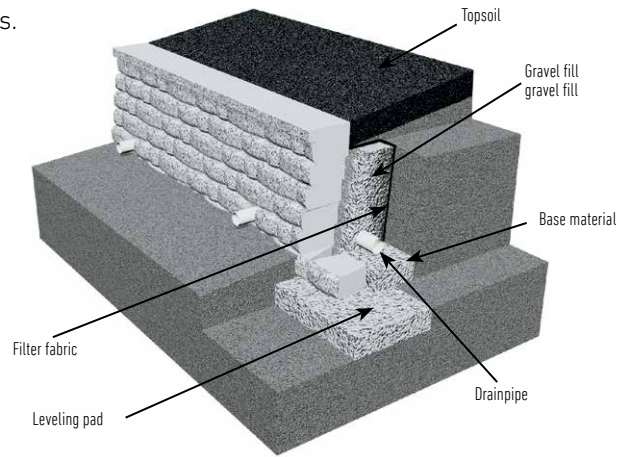

GEOSYNTHETIC-REINFORCED RETAINING WALL

The second category is a geosynthetic-reinforced wall, which needs to be designed by a qualified engineer. There are (theoretically) no height limitations with reinforced retaining walls, and they are used in larger applications. It requires more work area behind the structure.

The block of soil is stabilized by introducing reinforcement layers into the soil mass behind the facing units. The larger the stabilized soil mass, the more soil can be retained or held back. The geogrid in the soil extends past the theoretical failure plane and serves to create a large, rectangular mass of block and soil, restraining the retained soil.

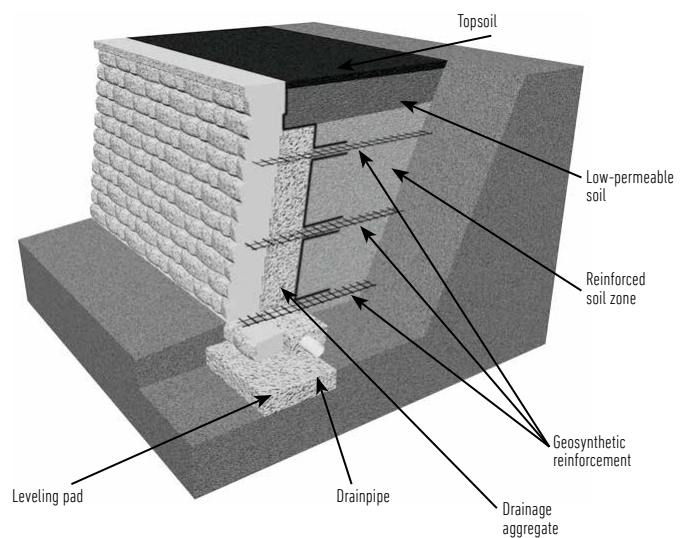

ANCHORPLEX® SYSTEM

The third category is the Anchorplex system, which offers a unique, non-conventional solution to problematic wall construction sites. It is a retaining wall built with Anchor™ products and structural backfill specified by ANCHOR Diamond, and backed by engineering support tools developed by Anchor.

Use of the Anchorplex system completely eliminates the need for the construction of a mechanically stabilized earth zone behind the wall facing and requires substantially less excavation than is usually necessary in geosynthetic-reinforced wall construction.

Contact ANCHOR Diamond at 1-877-295-5415 for more information about designing and building with the Anchorplex system.

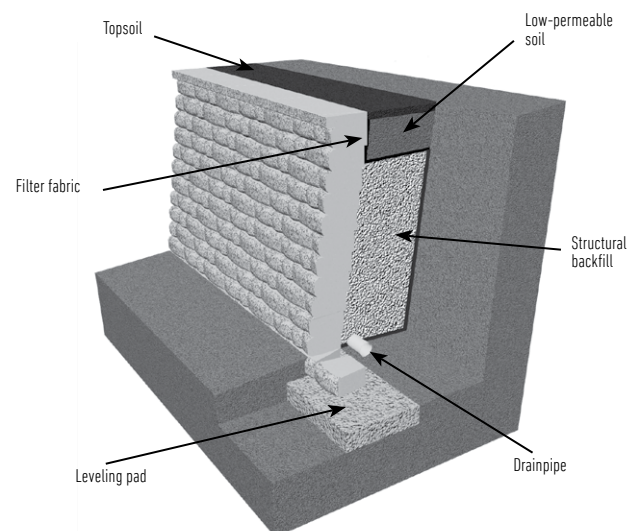

OTHER SEGMENTAL WALL APPLICATIONS

INDEPENDENT TERRACED WALLS

For each wall to be independent of others, they must be built using a 2:1 ratio: The upper wall must be built a distance away from the lower wall of at least twice the height of the lower wall. In addition, the upper wall must also be equal to or less than the height of the lower wall. Exceptions to this general rule include weak soil conditions or where slopes exist above, below or between wall locations. For example, if the lower terrace is 4 feet tall, the distance between the terraces must be at least 8 feet and the upper wall must not be higher than 4 feet.

Proper drainage is vital to maintaining stable, long-lasting terraced walls. A drainpipe must be installed so that the water is directed around or under the lower wall. Never place the drainpipe outlet for the upper wall above or behind the lower wall.

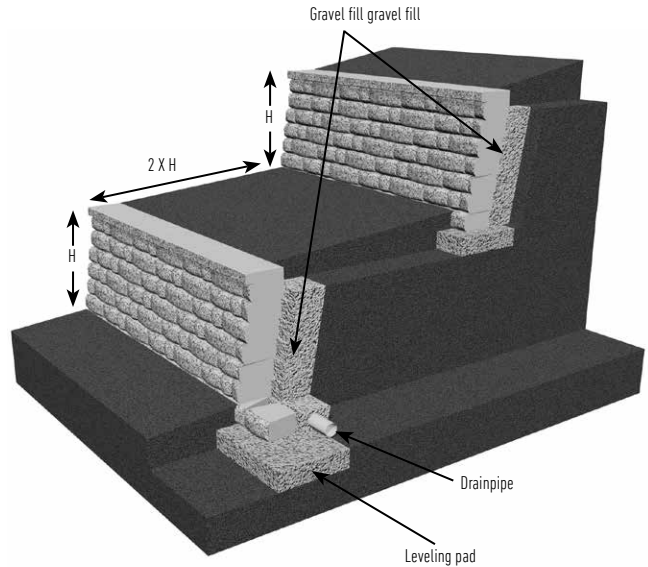

DEPENDENT TERRACED WALLS

When the distance between the lower and upper walls is less than twice the height of the lower wall, the walls become structurally dependent on each other. In this situation, it is important to take global stability into account, incorporating additional reinforcement — and longer layers — into the wall plan. In addition, structurally dependent walls require even more excavation, backfill and time. So plan ahead and be sure to check the wall plan for specific requirements. For structurally dependent walls, consult with a qualified engineer.

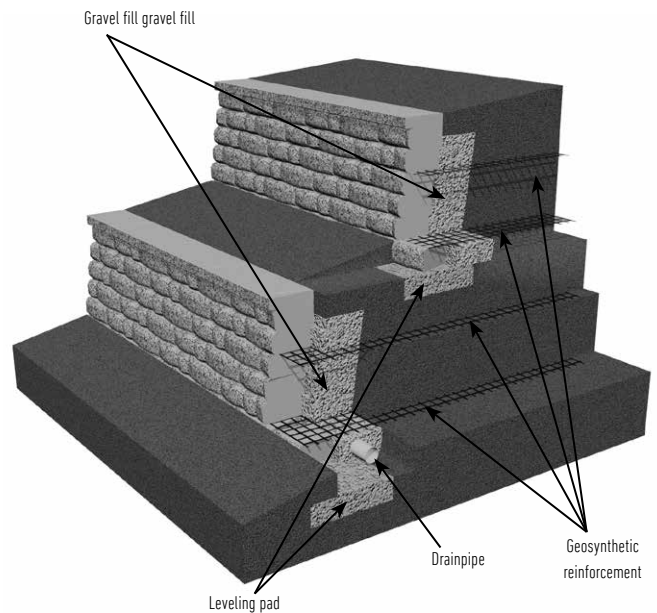

BEFORE YOU BEGIN

Advance planning and careful layout at the job site help ensure a successful retaining and freestanding wall project.

- Review the site plan to confirm lot lines, wall location, length and elevations.
- Understand on-site soils. Ideal soils are sand and gravel. For walls built in clay or poor soils, work with a local engineer to confirm the wall design and the required soil reinforcement. Black or organic soils should not be used as backfill.
- Confirm the location of underground utilities. Call 811.
- Seek all necessary building permits.
- Prepare a drawing of the site with the wall location, lengths and elevations.
- Plan drainage to avoid erosion or buildup of water behind the wall. Consider where the water will drain through the wall, where downspouts will expel and whether there's an underground sprinkler. For walls greater than three feet in height, a perforated drainpipe is recommended at the base of the aggregate to quickly remove large amounts of water.
- A best practice is to divert water away from the wall before it has an opportunity to enter the reinforced soil and gravel fill zone.
- Check the block delivered to ensure it is the correct product and color. Check the geogrids to confirm that it's the strength and weight specified in the engineering plans.
- Be sure to use the right tools. Hand tools include a shovel, 4-foot level, dead-blow hammer, 2- or 3-pound hammer, chisel, hand tamper, hydraulic splitter and string line. Power tools may include a circular saw with a diamond blade and a plate compactor.
- Always wear protective eye wear.

For additional wall installation references go to Belgard.com.











BRISA® WALL

NATURAL
COLLECTION 

FREESTANDING / RETAINING WALLS



Scan for additional
product information

RESIDENTIAL	COMMERCIAL	STEPS	COLUMNS	FIRE PITS	KITCHEN	FREESTANDING WALL	RETAINING WALL
							
✓	✓	✓	✓	✓	✓	✓	✓

SHAPES & SIZES

Freestanding Wall



6 x 6 x 5

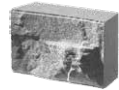

6 x 10 x 5

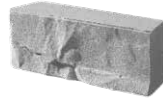

6 x 16 x 5



6 x 6 x 8

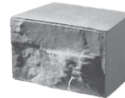

6 x 10 x 8



6 x 16 x 8

Retaining Wall

Column/Corner



6 x 16 x 8

Cap



3 x 8 x 13½

Cap End

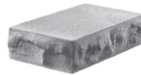

3 x 8 x 13½

Wall End



6 x 8 x 11

U Start Base Block®



Sold separately. Recommended for use with all available wall block units. Visit Belgard.com for full product information.

3½ x 18⅞ x 12*

*U Start Base Block actual coverage length is 16⅞

UNIT	SQFT/ PALLET	SQFT/ LAYER	LAYER/ PALLET	UNITS/ PALLET	UNITS/ SQFT	WEIGHT/ UNIT	WEIGHT/ PALLET
FREESTANDING WALL							
6 X 6 X 5	3.75	1.5	–	30	0.25	11	–
6 X 10 X 5	6.25	2.5	–	30	0.42	19	–
6 X 16 X 5	20	8	–	60	0.67	28	–
TOTAL	30	12	5	120	–	–	2632
RETAINING WALL							
6 X 6 X 8	3.75	1.25	–	15	0.25	20	–
6 X 10 X 8	6.25	2.09	–	15	0.42	31	–
6 X 16 X 8	20	6.67	–	30	0.67	52	–
TOTAL	30	10	3	60	–	–	2377
COLUMN/CORNER							
6 X 16 X 8	29	9.34	2	28	1.03	57	1648
CAP							
3 X 8 X 13½	68	8	144	126	0.63	22	2824
CAP END							
3 X 8 X 13½	6 SF 24 LF	3	2	36	0.67	21	854
WALL END							
6 X 8 X 11	13.98	6.99	2	63	0.33	37	2395
U START BASE BLOCK							
3½ X 18⅞ X 12	–	–	7	42	6	51	2839









DIAMOND® 9D

FREESTANDING / RETAINING WALLS

HERITAGE COLLECTION 



Scan for additional product information

RESIDENTIAL	COMMERCIAL	STEPS	COLUMNS	FIRE PITS	KITCHEN	FREESTANDING WALL	RETAINING WALL
							
✓		✓	✓	✓	✓	✓	✓

SHAPES & SIZES

Retaining Wall Small & Medium



6 x 6 x 9



6 x 10 x 9

Retaining Wall Large



6 x 17³/₄ x 9

Freestanding Wall Small & Medium



6 x 4⁶/₁₆ x 9



6 x 12¹⁰/₁₆ x 9

Freestanding Wall Large



6 x 15³/₄ / 17³/₄ x 9

Corner/Column



6 x 18 x 9

XL Cap



3 x 18¹²/₁₆ x 13

U Start Base Block®

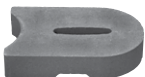

3¹/₂ x 18⁷/₁₆ x 12*

Sold separately. Recommended for use with all available wall block units. Visit Belgard.com for full product information.

*U Start Base Block actual coverage length is 16¹¹/₁₆











UNIT	SQFT/ PALLET	SQFT/ LAYER	LAYER/ PALLET	UNITS/ PALLET	UNITS/ SQFT	WEIGHT/ UNIT	WEIGHT/ PALLET
RETAINING WALL - SMALL AND MEDIUM BLOCKS							
6 X 9 X 9 6 X 10 X 9	35.52	–	–	48	.79	–	3090
RETAINING WALL - LARGE BLOCK							
6 X 15¾ / 17¾ X 9	35.52	–	–	48	.74	73	2900
FREESTANDING WALL - SMALL AND MEDIUM BLOCKS							
6 X 9 X 9 6 X 10 X 9	26.4	–	–	40 (SETS)	.71	73	2378
FREESTANDING WALL - LARGE BLOCK							
6 X 15¾ / 17¾ X 9	26.4	–	–	40	–	–	2378
CORNER/COLUMN							
8 X 17 X 8	35.5	–	–	40	1.13	75	3300
XL CAP							
6 X 18 X 9	–	–	8	72	–	49	3525
U START BASE BLOCK							
3½ X 18¾ X 12	–	–	7	42	6	51	2839

DIAMOND PRO®

RETAINING WALLS



Scan for additional product information

RESIDENTIAL	COMMERCIAL	STEPS	COLUMNS	FIRE PITS	KITCHEN	FREESTANDING WALL	RETAINING WALL
							
✓	✓	✓	✓				✓

SHAPES & SIZES

Diamond Pro Straight Face

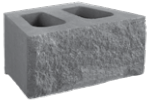

8 x 18 x 12

Diamond Pro Corner

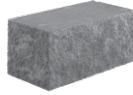

8 x 18 x 9

Universal Cap

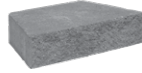

4 x 17 / 14 x 10

U Start Base Block®



3½ x 18⁷/₁₆ x 12*

Sold separately. Recommended for use with all available wall block units. Visit Belgard.com for full product information.

**U Start Base Block actual coverage length is 16¹¹/₁₆.*

UNIT	SQFT/PALLET	SQFT/LAYER	LAYER/PALLET	UNITS/PALLET	UNITS/SQFT	WEIGHT/UNIT	WEIGHT/PALLET
------	-------------	------------	--------------	--------------	------------	-------------	---------------

DIAMOND PRO STRAIGHT FACE

8 X 18 X 12	45	9	5	45	1	80	3553
-------------	----	---	---	----	---	----	------

DIAMOND PRO CORNER

8 X 18 X 9	32	10	3	30	–	100	2468
------------	----	----	---	----	---	-----	------

UNIVERSAL CAP

4 X 18 / 12 X 10½	–	–	5	60	–	49	3225
-------------------	---	---	---	----	---	----	------

U START BASE BLOCK

3½ X 18 ⁷ / ₁₆ X 12	–	–	7	42	6	51	2839
---	---	---	---	----	---	----	------











MELVILLE™ WALL

FREESTANDING / RETAINING WALLS

METROPOLITAN COLLECTION 



Scan for additional product information

RESIDENTIAL	COMMERCIAL	STEPS	COLUMNS	FIRE PITS	KITCHEN	FREESTANDING WALL	RETAINING WALL
							
✓	✓	✓	✓	✓	✓	✓	✓

SHAPES & SIZES

Wall Block

Cap*



4 x 20 x 10

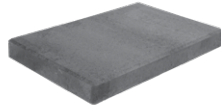

2 x 20 x 13

**Can be used as cap and/or wall block*

UNIT	SQFT/ PALLET	SQFT/ LAYER	LAYER/ PALLET	UNITS/ PALLET	UNITS/ SQFT	WEIGHT/ UNIT	WEIGHT/ PALLET
------	-----------------	----------------	------------------	------------------	----------------	-----------------	-------------------

WALL BLOCK

4 X 20 X 10	26.67	4.44	6	48	1.79	63.75	3060
-------------	-------	------	---	----	------	-------	------

CAP









2 X 20 X 13	100 LF	10 LF	10	60	1.66 LF	41.67	2500
-------------	--------	-------	----	----	---------	-------	------



FREESTANDING / RETAINING WALLS / COLUMN



Scan for additional product information

RESIDENTIAL	COMMERCIAL	STEPS	COLUMNS	FIRE PITS	KITCHEN	FREESTANDING WALL	RETAINING WALL
							
✓	✓	✓	✓	✓	✓	✓	✓

SHAPES & SIZES

FSW/SRW/Column Wall Block

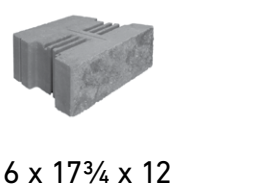

Anchor™ Fiberglass Pins*

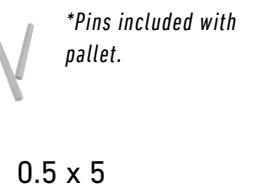

XL™ Cap



U Start Base Block*



(Sold Separately)
Recommended for use with all available wall block units. Visit Belgard.com for full product information.

*Note: U Start Base Block actual coverage length is 16⅞

UNIT	SQFT/PALLET	SQFT/LAYER	LAYER/PALLET	UNITS/PALLET	UNITS/SQFT	WEIGHT/UNIT	WEIGHT/PALLET
------	-------------	------------	--------------	--------------	------------	-------------	---------------

WALL BLOCK

6 X 17¾ X 12	33.75	–	5	45	.75	77	3455
--------------	-------	---	---	----	-----	----	------

CAP

3 X 18 / 12 X 13	–	–	8	72	–	49	3525
------------------	---	---	---	----	---	----	------

U START BASE BLOCK

3½ X 18⅞ X 12	–	–	7	42	6	51	2839
---------------	---	---	---	----	---	----	------

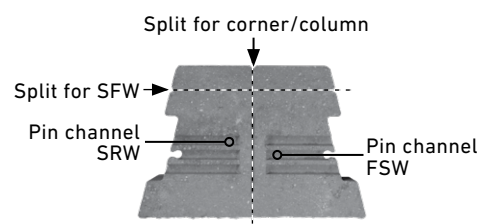

TANDEM® WALL

FREESTANDING / RETAINING WALLS

NATURAL COLLECTION

METROPOLITAN COLLECTION



Scan for additional product information

RESIDENTIAL	COMMERCIAL	STEPS	COLUMNS	FIRE PITS	KITCHEN	FREESTANDING WALL	RETAINING WALL
✓	✓	✓	✓	✓	✓	✓	✓

SHAPES & SIZES

Ashlar Tandem™



7 x 13^{3/16} x 2^{5/8}



7 x 15^{13/16} x 2^{5/8}



7 x 18^{7/16} x 2^{5/8}

Lamina Tandem™



7 x 13^{3/16} x 2^{5/8}



7 x 15^{13/16} x 2^{5/8}



7 x 18^{7/16} x 2^{5/8}

Melville Tandem™



7 x 13^{3/16} x 2^{5/8}



7 x 15^{13/16} x 2^{5/8}



7 x 18^{7/16} x 2^{5/8}

Tandem Column Kit



Tandem Unit
7 x 18^{7/16} x 2^{5/8}



Column Grid Height 42

Tandem Modular Grid

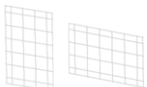

42 x 28^{3/8}

Tandem Cap Unit



15 x 24 x 3^{1/4}

8" Connecting Member



3 x 12^{1/8} x 12
(Sold Separately)

Tandem Modular Block® with Universal Connector



7^{1/16} x 7^{7/8} x 7^{7/8}

U Start Base Block®

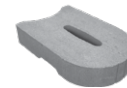

3^{1/2} x 18^{1/2} x 12*

Connector



*Recommended for use with all available wall block units. (Sold Separately)

NOTE: U Start Base Block actual coverage length is 16^{1/16}.









UNIT	SQFT/ PALLET	SQFT/ LAYER	LAYER/ PALLET	UNITS/ PALLET	UNITS/ LAYER	WEIGHT/ LAYER	WEIGHT/ PALLET
ASHLAR TANDEM WALL UNITS							
7 X 13³/₁₆ X 2⁵/₈	19.2	3.2	–	30	.64	–	570
7 X 15¹³/₁₆ X 2⁵/₈	23.1	3.85	–	30	.77	–	696
7 X 18⁷/₁₆ X 2⁵/₈	27	4.5	–	30	.9	–	816
TOTAL	70.1	11.69	6	90	2.31	175	2082
MELVILLE TANDEM WALL UNITS							
7 X 13³/₁₆ X 2⁵/₈	19.2	3.2	–	30	.64	95	570
7 X 15¹³/₁₆ X 2⁵/₈	23.1	3.85	–	30	.77	116	696
7 X 18⁷/₁₆ X 2⁵/₈	27	4.5	–	30	.90	136	816
TOTAL	70.1	11.69	6	90	2.31	347	2082
LAMINA TANDEM WALL UNITS							
7 X 13¹³/₁₆ X 2⁵/₈	15.576	2.596	–	24	.649	77.08	462.48
7 X 15⁷/₁₆ X 2⁵/₈	18.696	3.116	–	24	.779	92.52	555.12
7 X 18¹/₁₆ X 2⁵/₈	21.816	3.636	–	24	.909	108	648
TOTAL	56.08	9.35	6	72	–	277.6	1666
TANDEM CAP UNIT							
15 X 24 X 3¹/₄	20 SF 64 LF	2.5	8	32	.625 SF 2 LF	373.75	2990
COLUMN KIT							
7 X 18⁷/₁₆ X 2⁵/₈	45.43	9	5	45	2 COLUMNS/ PALLETS	461.2	1350
TANDEM MODULAR BLOCK							
7⁷/₁₆ X 7⁷/₈ X 7⁷/₈	49.29	12.32	4	128	0.389	704	2816
U START BASE BLOCK							
3¹/₂ X 18¹/₂ X 12	–	–	7	42	–	51	2839

WESTON STONE™

FREESTANDING / RETAINING WALLS



Scan for additional product information

RESIDENTIAL	COMMERCIAL	STEPS	COLUMNS	FIRE PITS	KITCHEN	FREESTANDING WALL	RETAINING WALL
							
✓		✓	✓	✓	✓	✓	✓

SHAPES & SIZES

3-Piece



4 x 8 / 5 x 8



4 x 12 / 9 x 8

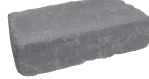

4 x 16 / 13 x 8

Universal



4 x 12 x 8

Weston Stone Cap

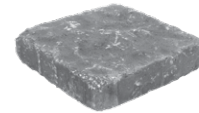

10½ x 10½ x 2¾

UNIT	SQFT/ PALLET	SQFT/ LAYER	LAYER/ PALLET	UNITS/ PALLET	SQFT/ UNITS	WEIGHT/ LAYER	WEIGHT/ PALLET
------	-----------------	----------------	------------------	------------------	----------------	------------------	-------------------

3-PIECE MODULAR

4 X 8 / 5 X 8	-	-	-	-	-	16.9	-
4 X 12 / 9 X 8	-	-	-	-	-	26.1	-
4 X 16 / 13 X 8	-	-	-	-	-	36.4	-
TOTAL	42	6	7	126	-	-	3400

UNIVERSAL

4 X 12 X 8	40	6.6	6	120	-	30	3614
------------	----	-----	---	-----	---	----	------

WESTON STONE CAP

10½ X 10½ X 2¾	112	9.33	12	144	.83	-	3136
----------------	-----	------	----	-----	-----	---	------

WESTON STONE™ INSTALLATION INSTRUCTIONS

This is a pinless system. Maximum wall height is 2½ feet. Walls exceeding 2½ feet in height may require geogrid reinforcing and the consultation of a qualified engineer. Contact your Belgard sales representative or dealer for assistance.

Weston Stone wall units must be glued with a quality construction adhesive to develop the necessary mechanical bond. All measurements herein are approximate. Natural materials are used in the manufacturing of this product.

WESTON STONE™ WALL PATTERNS

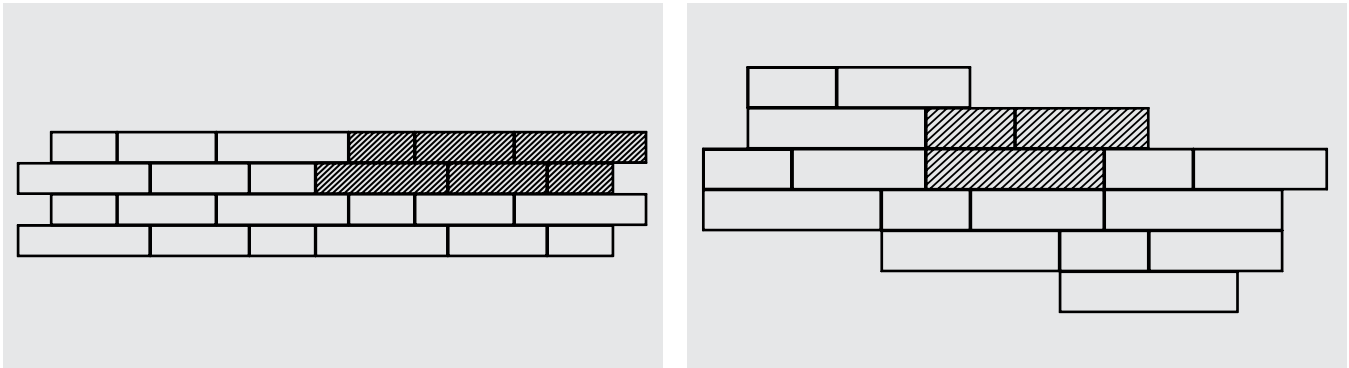

TYPICAL CROSS SECTION WITH WESTON STONE SEAT WALL

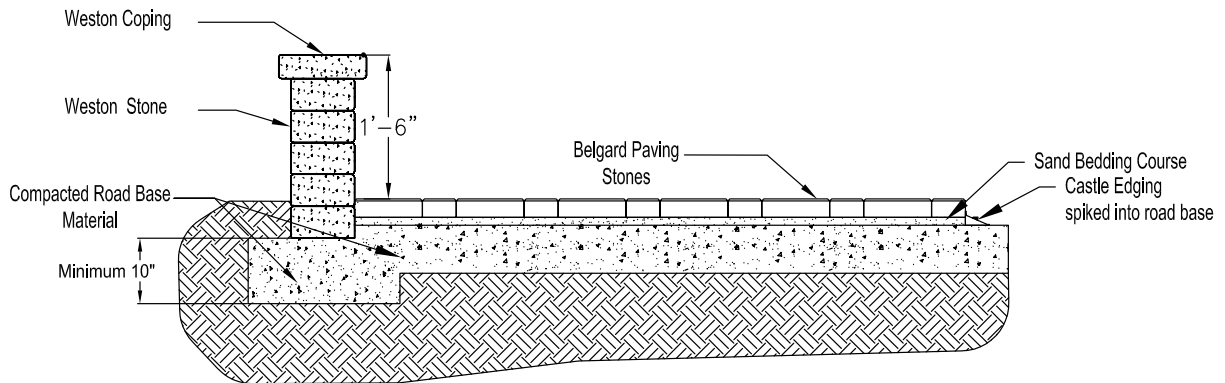

TREE RINGS WITH WESTON STONE

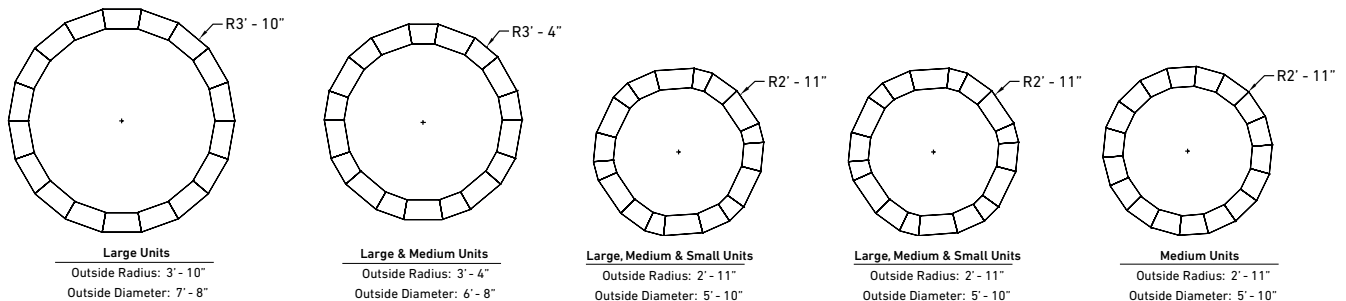

FIRE FEATURES



FIRE FEATURES INSTALLATION GUIDE

76 Installation Instructions

FIRE FEATURES

77 Melville™ Series

80 Bordeaux™ Series

83 Brighton™ Series

85 Bristol™ Series

88 Weston Stone Fire Pit Kit

STANDARD INSTALLATION INSTRUCTIONS

GRAVEL BASE

Gravel Fill shall be a clean angular stone or angular granular fill meeting the following gradation as determined in accordance with ASTM D 422.

<u>Sieve Size</u>	<u>Percent Passing</u>
1-in	100
3/4-in	75-100
No. 4	0-60
No. 40	0-50
No. 200	0-12

FOUNDATION PREPARATION

Following excavation of the leveling pad, foundation soil shall be examined to assure the actual foundation soil strength meets or exceeds the assumed design bearing strength. Soils not meeting the required strength shall be removed and replaced with soil meeting the design criteria.



*Scan for Fortified Installation Method
to be used with soft soils or expanding clays*

LEVELING PAD PREPARATION

A minimum 18-in thick layer or compacted granular material shall be placed for use as a leveling pad up to the grades and locations as shown on the construction drawings. The granular base shall be compacted to a firm, level bearing pad on which to place the bottom level of the unit. A leveling pad consisting of 6-in (minimum) thick lean, unreinforced concrete may be used at the contractor's option, or if so detailed on the plans. The leveling pad should extend a minimum of 6-in from the toe and from the heel of the unit base.

GRAVEL FILL

Gravel fill shall be placed to the minimum finished thickness and width shown on the construction plans.

Gravel lifts shall be a maximum thickness of 6-in.

Lifts shall be compacted by three passes of a light weight vibratory plate compactor.

For areas not affected by freeze-thaw conditions please contact your local Belgard sales representative for further installation information.

MELVILLE™ SERIES

METROPOLITAN
COLLECTION 



*Scan for additional
product information*



MELVILLE™ SERIES

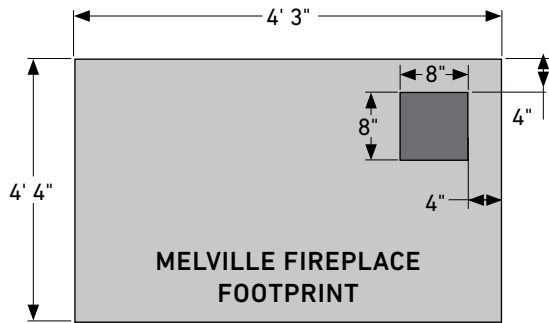

FIREPLACE

Rough Dimensions:
2' 7" D x 4' 3" W x 7' 8" H

Approximate Weight:
4205 lbs.

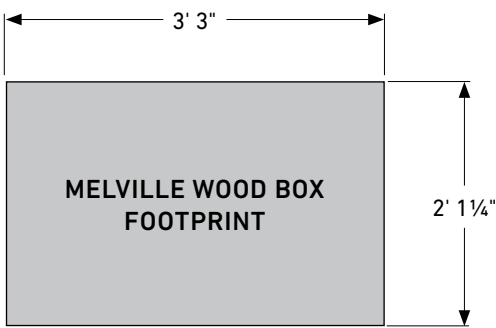
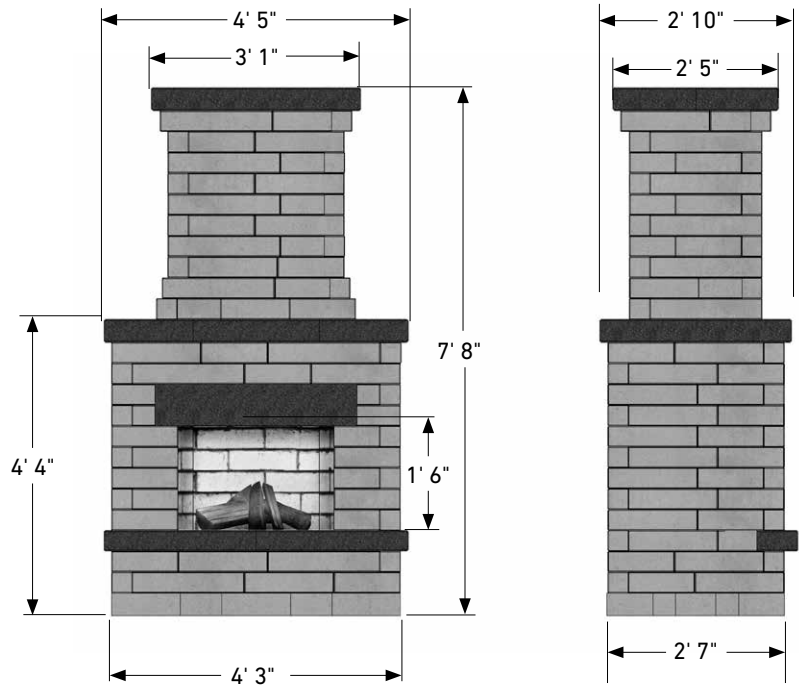

WOOD BOXES

Rough Dimensions:
2' 1" D x 3' 3" W x 3' 1" H

Approximate Weight:
3070 lbs. or 1535 lbs. each

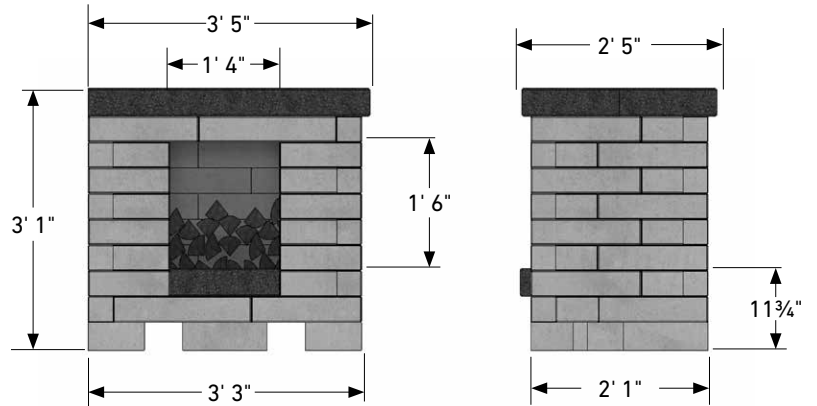

GRILL ISLAND

Rough Dimensions:
2' 8" D x 5' 11" W x 3' 5" H

Approximate Weight:
3500 lbs.

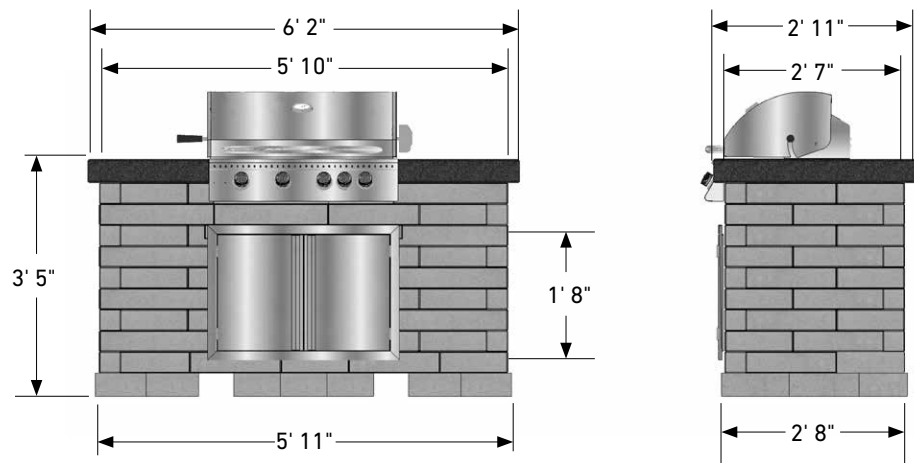

MELVILLE™ SERIES

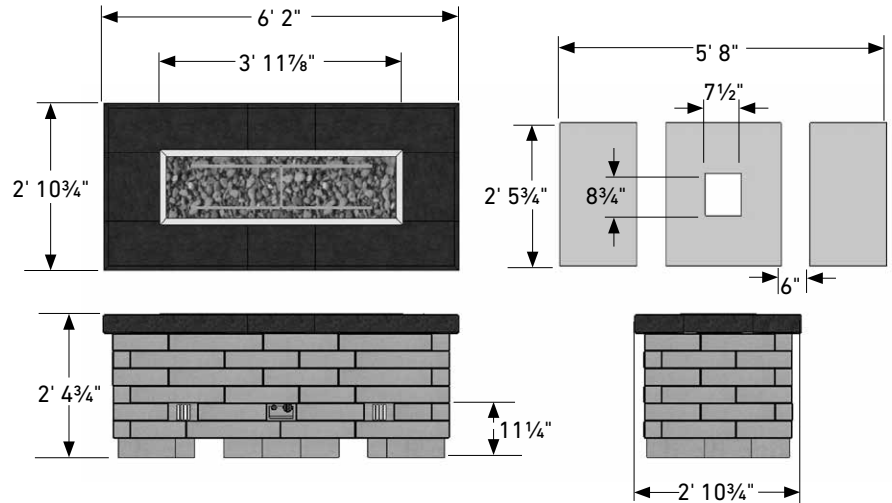

LINEAR FIRE TABLE

Rough Dimensions:
2' 6" D x 5' 8" W x 2' 5" H

Approximate Weight:
2500 lbs.

LINEAR FIREPLACE

Rough Dimensions:
2' 6" D x 7' 1" W x 5' 4" H

Approximate Weight:
4000 lbs.

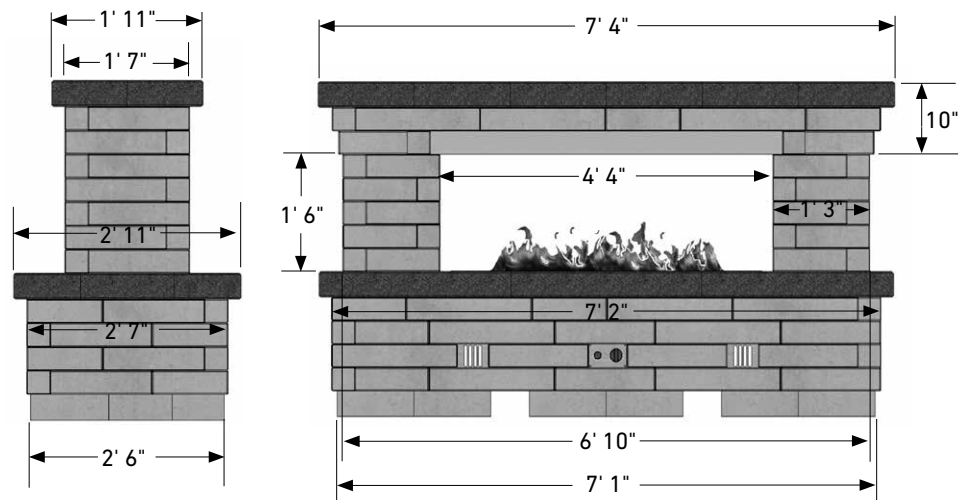

FIREPLACE

13070020
Melville Wood Fireplace
Colors: Scandina Gray/Midnight

WOOD BOXES

13140010
Melville Wood Boxes (Pair)
Colors: Scandina Gray/Midnight

36" wood burning fireplace can be converted to a vented gas unit on-site.

GRILL ISLAND

13110028
Melville Grill Island
Colors: Scandina Gray/Midnight

LINEAR FIREPLACE

13000026
Melville Linear Fireplace
Colors: Scandina Gray/Midnight

LINEAR FIRE TABLE

13000027
Melville Linear Fire Table
Colors: Scandina Gray/Midnight

BORDEAUX™ SERIES

NATURAL
COLLECTION 



Scan for additional
product information

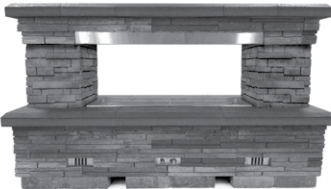
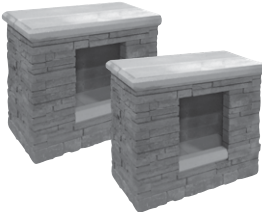

BORDEAUX™ SERIES

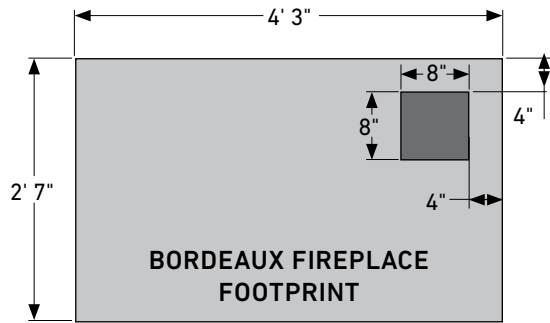

FIREPLACE

Rough Dimensions:
2' 7" D x 4' 3" W x 7' 8" H

Approximate Weight:
4200 lbs.

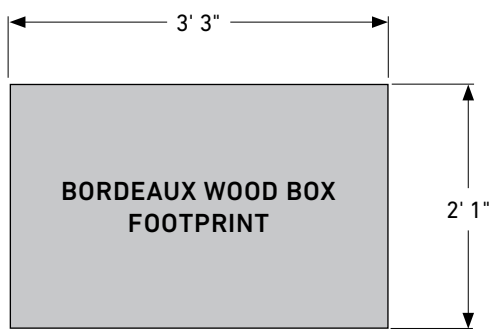
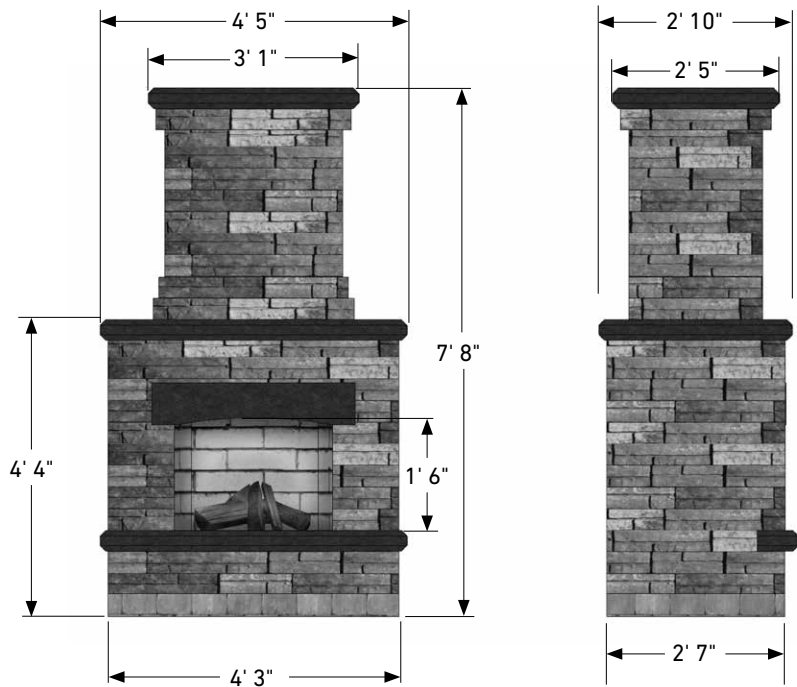

WOOD BOXES

Rough Dimensions:
2' 1" D x 3' 5" W x 3' 1" H

Approximate Weight:
3070 lbs.

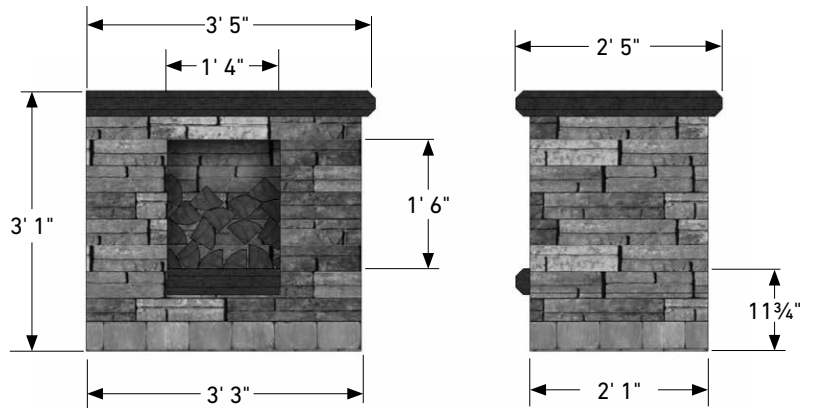

GRILL ISLAND

Rough Dimensions:
2' 8" D x 6' W x 3' 5" H

Approximate Weight:
2500 lbs.

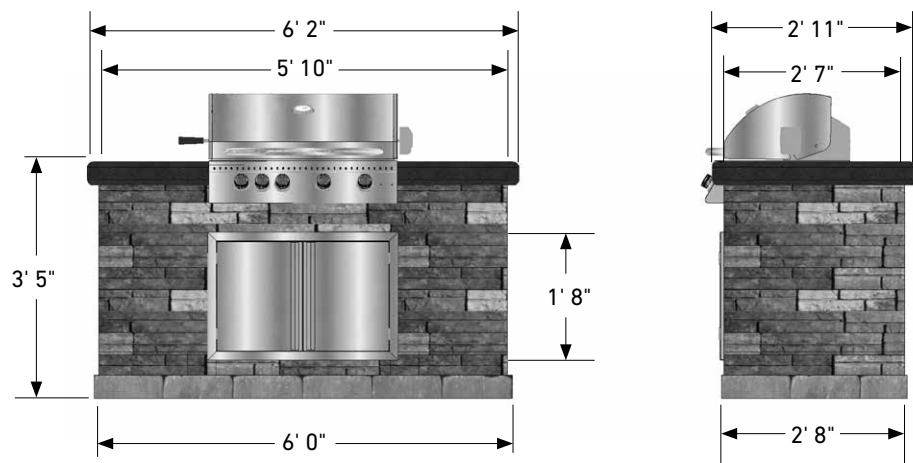

BORDEAUX™ SERIES

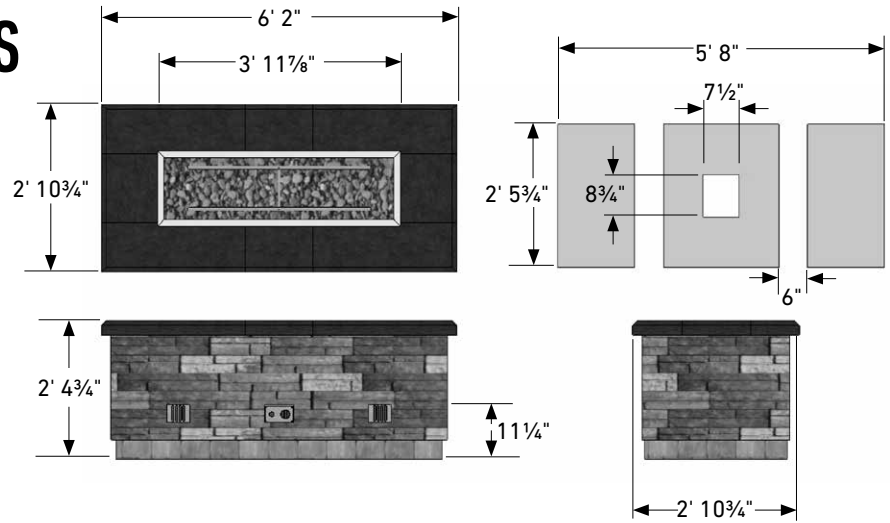

LINEAR FIRE TABLE

Rough Dimensions:
2' 10³/₄" D x 6' 2" W x 2' 4³/₄" H
Approximate Weight:
2500 lbs.

LINEAR FIREPLACE

Rough Dimensions:
2' 6" D x 7' 1" W x 5' 4" H
Approximate Weight:
3700 lbs.

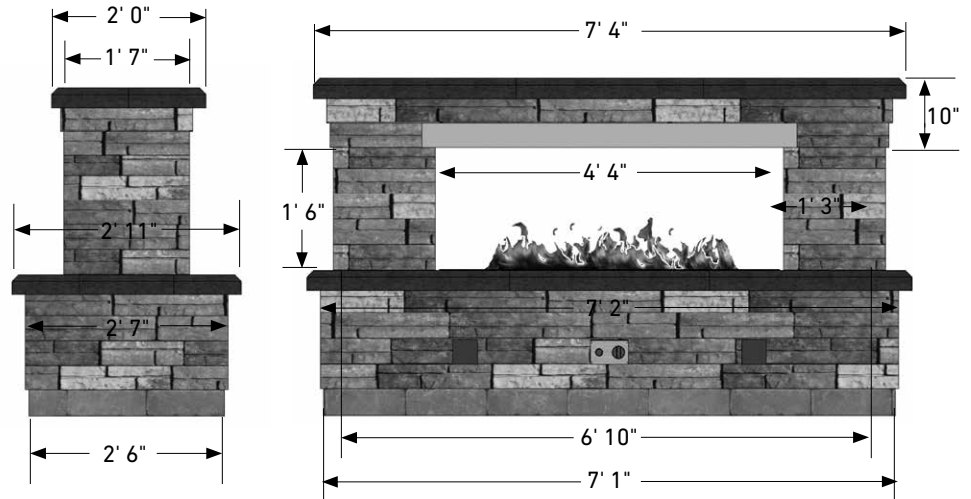

FIREPLACE

70300791

Bordeaux Wood Fireplace
Colors: Lamina Sienna/Cordova
Stone Buff Base + Top

13070014

Bordeaux Wood Fireplace
Colors: Lamina Sienna/Cordova
Midnight Base + Top

13070012

Bordeaux Wood Fireplace
Colors: Lamina Pewter
Midnight Base + Top

WOOD BOXES

13140001

Bordeaux Wood Boxes (Pair)
Colors: Lamina Sienna/
Cordova Stone Buff

13140020

Bordeaux Wood Boxes (Pair)
Colors: Lamina Sienna/
Cordova Stone Midnight

13140021

Bordeaux Wood Boxes (Pair)
Colors: Lamina Pewter
Midnight Base + Top

GRILL ISLAND

13110010

Bordeaux Grill Island (NG)
Colors: Lamina Sienna/
Cordova Stone Buff
+ Stainless

13110011

Bordeaux Grill Island (LP)
Colors: Lamina Sienna/
Cordova Stone Buff
+ Stainless

13110014

Bordeaux Grill Island (NG)
Colors: Lamina Sienna/
Cordova Stone Midnight
+ Stainless

13110015

Bordeaux Grill Island (LP)
Colors: Lamina Sienna/
Cordova Stone Midnight
+ Stainless

LINEAR FIREPLACE

13000021

Bordeaux Linear Fireplace
Colors: Sienna/Buff

13000019

Bordeaux Linear Fireplace
Colors: Sienna/Midnight

13000020

Bordeaux Linear Fireplace
Colors: Pewter/Midnight

LINEAR FIRE TABLE

13000023

Bordeaux Linear Fire Table
Colors: Sienna/Buff

13000204

Bordeaux Linear Fire Table
Colors: Sienna/Midnight

13000203

Bordeaux Linear Fire Table
Colors: Pewter/Midnight

36" wood burning fireplace can be converted to a vented gas unit on-site.

BRIGHTON™ SERIES

HERITAGE
COLLECTION **H**



*Scan for additional
product information*



BRIGHTON™ SERIES

FIREPLACE

Rough Dimensions:
3' 4" D x 4' 4" W x 8' 4" H

Approximate Weight:
5825 lbs.

FIREPLACE

70580007

Brighton Fireplace

Colors: Weston Gascony Tan/Urbana
Ashbury Haze Base + Top

70580378

Brighton Fireplace

Colors: Weston Cotswold Mist/Urbana
Brookstone Slate Base + Top

36" wood burning fireplace can be converted to a vented gas unit on-site.

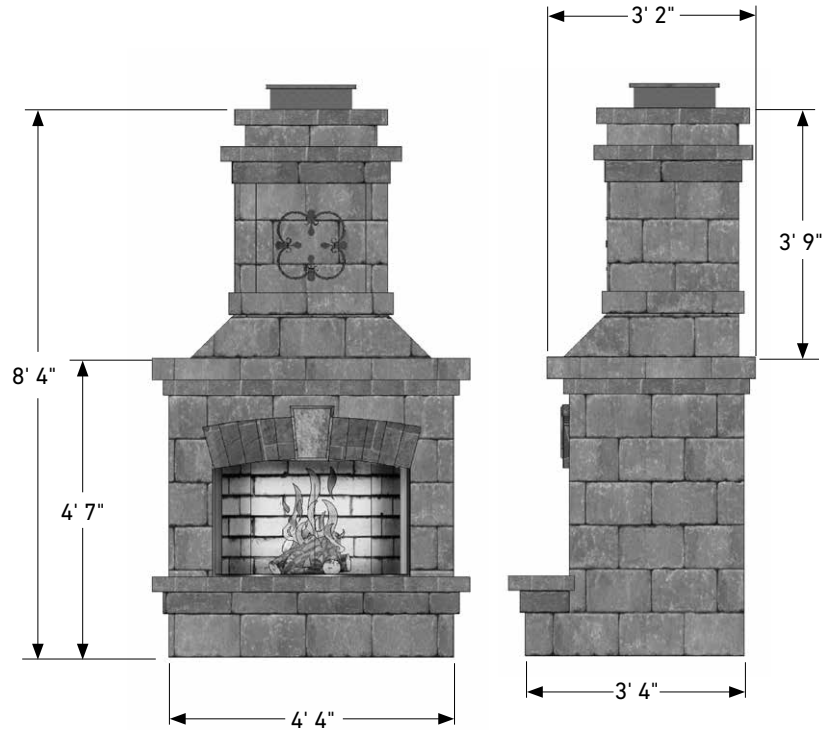

WOOD BOXES

Rough Dimensions:
2' 4" D x 3' W x 2' 11" H

Approximate Weight:
3200 lbs.

WOOD BOXES

70300046

Brighton Wood Boxes (Pair)

Colors: Weston Gascony Tan/Urbana
Ashbury Haze

70580291

Brighton Wood Boxes (Pair)

Colors: Weston Cotswold Mist/Urbana
Brookstone Slate

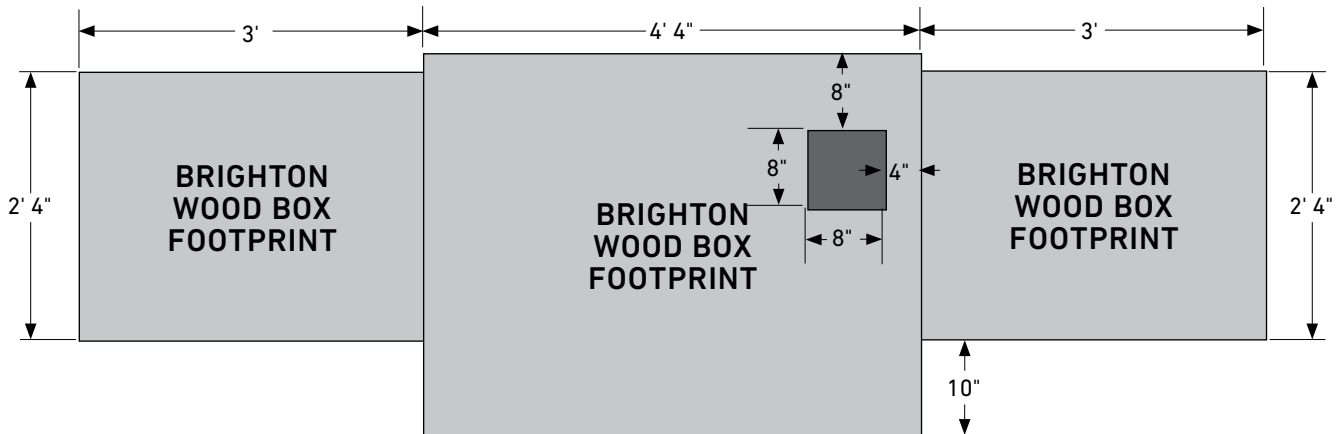
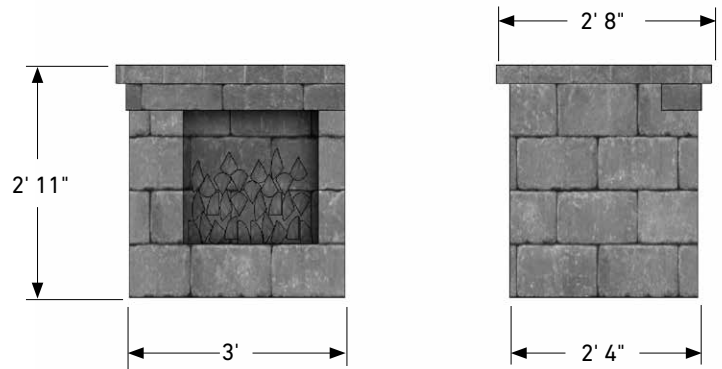

BRISTOL™ SERIES

NATURAL
COLLECTION



Scan for additional
product information



BRISTOL™ SERIES

FIREPLACE

Rough Dimensions:
3' D x 5' W x 9' 6" H

Approximate Weight:
5825 lbs.

FIREPLACE

70580261

Colors: Weston Gascony Tan/
Arbel Ashbury Haze Base + Top

70580312

Colors: Weston Cotswold Mist/
Arbel Brookstone Slate Base + Top

36" wood burning fireplace can be
converted to a vented gas unit on-site.

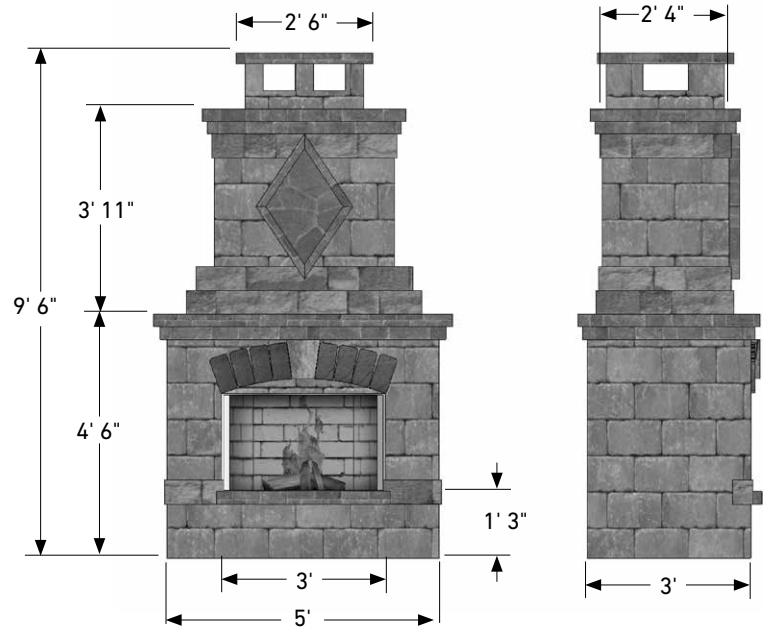

WOOD BOXES

Rough Dimensions:
2' 4" D x 3' W x 3' 3" H

Approximate Weight:
3950 lbs.

WOOD BOXES (PAIR)

70580334

Colors: Weston Gascony Tan/
Urbana Ashbury Haze

70580534

Colors: Weston Cotswold
Mist/Urbana
Brookstone Slate

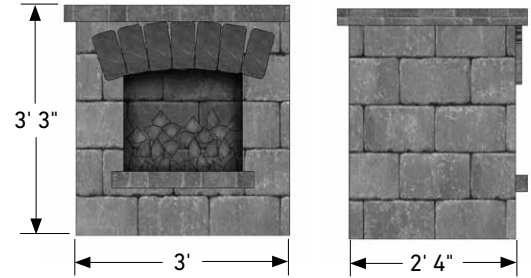

HEARTH

Rough Dimensions:
2' D x 5' W x 11" H

Approximate Weight:
1180 lbs.

ARCHED HEARTH

70580262

Colors: Weston Gascony Tan/
Arbel Ashbury Haze

70580309

Colors: Weston Cotswold Mist/
Arbel Brookstone Slate

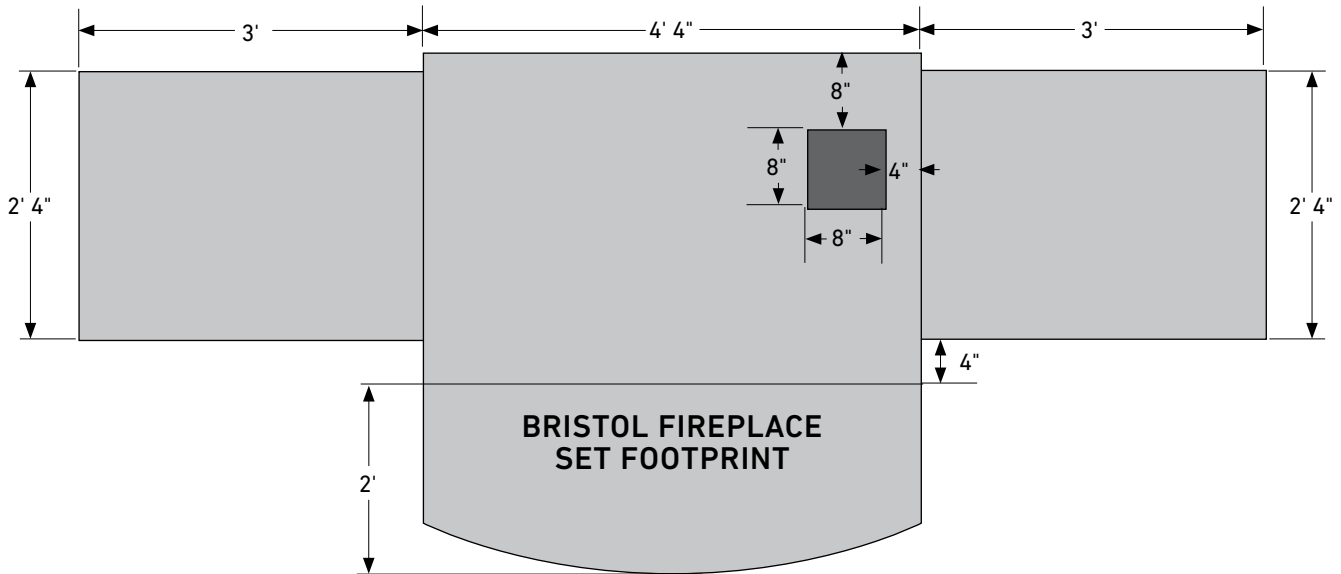
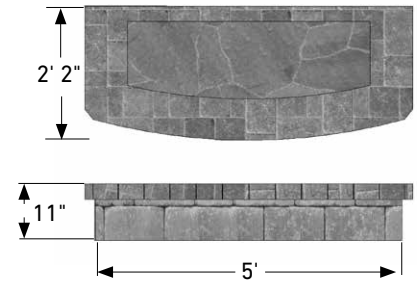

BRISTOL™ SERIES

GRILL ISLAND

Rough Dimensions:
3' D x 6' 8" W x 4' 4" H

Approximate Weight:
3980 lbs.

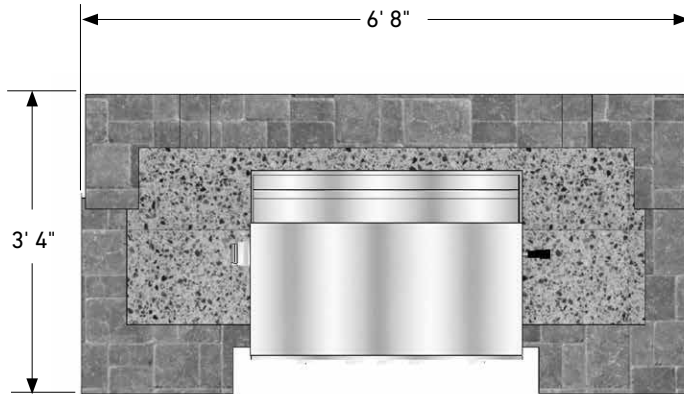

GRILL ISLAND

13110008

Bristol Grill Island (NG)

Colors: Weston Gascony Tan/
Arbel Ashbury Haze + Stainless







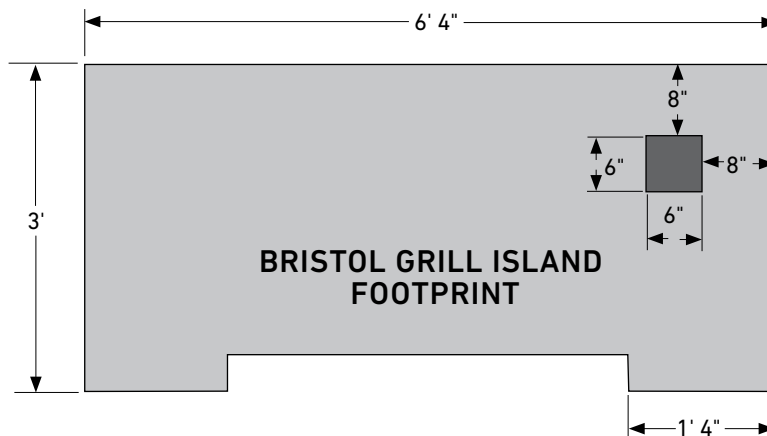
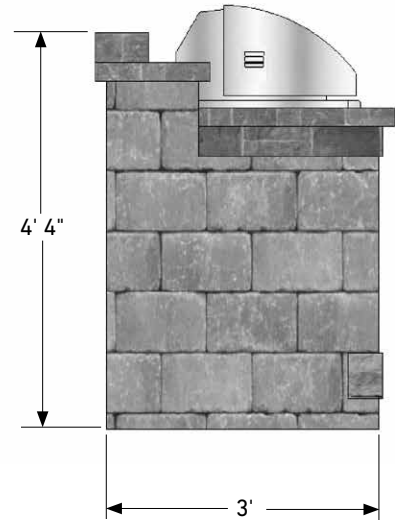
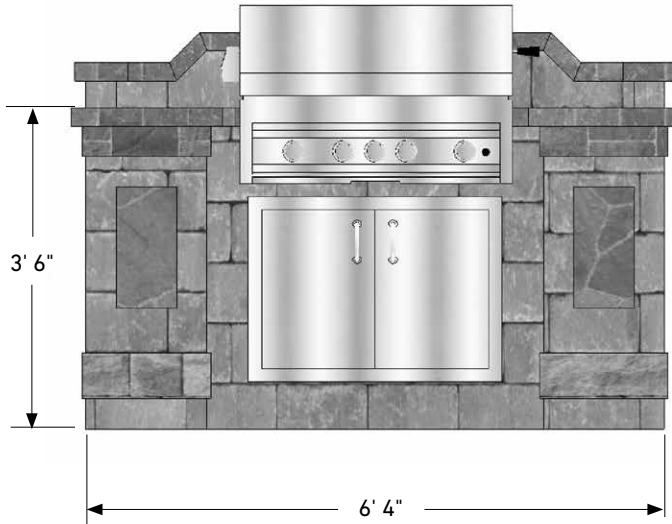

11130250

Bristol Grill Island (LP)

Colors: Weston Gascony Tan/
Arbel Ashbury Haze + Stainless



WESTON STONE™ FIRE PIT KITS

RESIDENTIAL	COMMERCIAL	STEPS	COLUMNS	FIRE PITS	KITCHEN	FREESTANDING WALL	RETAINING WALL
							
✓				✓			

SHAPES & SIZES

Fire Pit Kit



4 x 8 x 8

Outside is 4"7" in diameter
Stacks up to 4 rows high

Fire Pit Kit with Elements™ Smoke-less Fire Ring



4 x 8 x 8



UNIT	SQFT/ PALLET	SQFT/ LAYER	LAYER/ PALLET	UNITS/ PALLET	UNITS/ SQFT	WEIGHT/ UNIT	WEIGHT/ PALLET
FIRE PIT KIT							
4 X 8 X 8	-	-	-	36	-	-	-

FIRE PIT KITS INSTALLATION INSTRUCTIONS

- Always use in accordance with all applicable local and state fire codes
- Failure to follow these instructions could result in a hazardous fire causing property damage or physical injury
- Caution: For outdoor use only
- Use the fire ring on stone, dirt or sand surfaces
- For adult use only — do not allow children to use the fire ring
- Do not use on lawns, wooden decks, concrete or asphalt
- Do not use fire ring indoors or under a patio roof
- Do not use in windy conditions
- Do not leave fire unattended at any time
- Do not use under tree branches, trellis, or overhangs of any kind, including covered porches
- Do not use flammable liquids such as gasoline, alcohol, diesel fuel, kerosene, or charcoal lighter fluid to light or relight fires as this may also cause paint to flake off fire ring
- Care should be taken to make sure all combustible material is far enough away from the fire ring not to ignite it
- Avoid using softwoods such as pine or cedar because they are likely to throw sparks — hardwoods are recommended
- Keep children and pets away from the fire ring while it is in use
- Exercise the same precautions you would with any open fire
- Do not wear flammable or loose clothing when tending an open fire
- Avoid touching surfaces as they will be extremely hot
- Assure the fire is completely extinguished before leaving fire ring
- Any modifications to this appliance may be dangerous and are not permitted

ADDITIONAL MATERIALS NEEDED

- Tamper
- Level
- 2 Bags of Leveling Sand
- 2 Tubes of Concrete Adhesive
- Caulk Gun
- 3 Bags of Gravel or Lava Rock
- Shovel
- Optional Marking Paint or Chalk





ACCESSORIES

ACCESSORIES

- 91 Anglia Edger®
- 92 Artforms™
- 94 Granika Step®
- 95 Landings™ Step Unit
- 98 Marina™ Coping
- 100 Konza Caps - Fire Pit, Pillar & Seat Wall caps



Scan for additional
product information

RESIDENTIAL	COMMERCIAL	STEPS	CAPS	COPING
				
✓				

SHAPES & SIZES

Multi-Piece



5 1/4 x 7 5/8 x 8



5 1/4 x 10 x 8



5 1/4 x 15 5/8 x 8

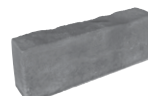

5 1/4 x 17 5/8 x 8









UNIT	SQFT/ PALLET	SQFT/ LAYER	LAYER/ PALLET	UNITS/ PALLET	UNITS/ SQFT	WEIGHT/ UNIT	WEIGHT/ PALLET
------	-----------------	----------------	------------------	------------------	----------------	-----------------	-------------------

MULTI-PIECE

5 1/4 X 7 5/8 X 8	-	-	-	16	-	25	-
5 1/4 X 10 X 8	-	-	-	16	-	31	-
5 1/4 X 15 5/8 X 8	-	-	-	16	-	47	-
5 1/4 X 17 5/8 X 8	-	-	-	24	-	52	-
TOTAL	78.4	-	3	120	-	-	2550



Scan for additional product information

RESIDENTIAL	COMMERCIAL	STEPS	CAPS	FIRE PITS	KITCHEN	FREESTANDING WALL	RETAINING WALL
							
✓	✓		✓	✓	✓	✓	

SHAPES & SIZES

18 x 36*

6 x 36*

Installation Hardware



3 x 18 x 36

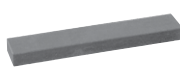

3 x 6 x 36

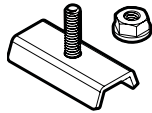

Anchor Slide & Nut

50 per box

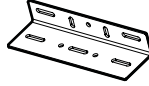

Joining Plate

10 per box

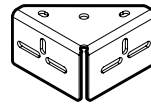

Outer Corner

10 per box

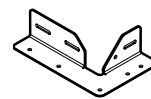

Inner Corner

10 per box

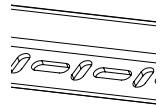

Stretcher

10 in a bundle

*Pallets contain both open and closed ended units

UNIT	SQFT/PALLET	SQFT/LAYER	LAYER/PALLET	UNITS/PALLET	UNITS/LAYER	UNITS/SQFT	WEIGHT/PALLET
------	-------------	------------	--------------	--------------	-------------	------------	---------------

3 x 18 x 36	81	9	9	18**	2	4.5	2682***
3 x 6 x 36	31.5	10.5	3	21**	7	1.5	1029

**Total number of both open and closed end panels. 18 x 36 pallets contain 9 of each. 6 x 36 pallets contain 3 open end panels and 18 closed end panels

***150lbs is the weight for the closed units, 148lbs is the weight for the open units.

18 X 36 X 3

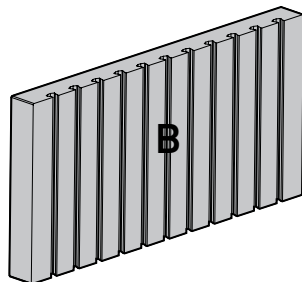
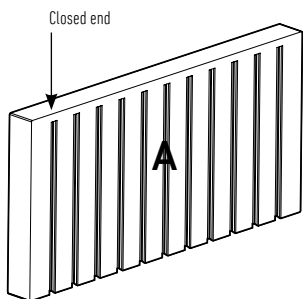

6 X 36 X 3

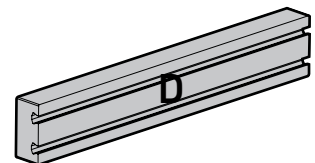
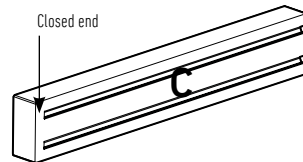

PANEL CONFIGURATIONS

IDEAL:

This configuration uses equal number of panel A and panel B.

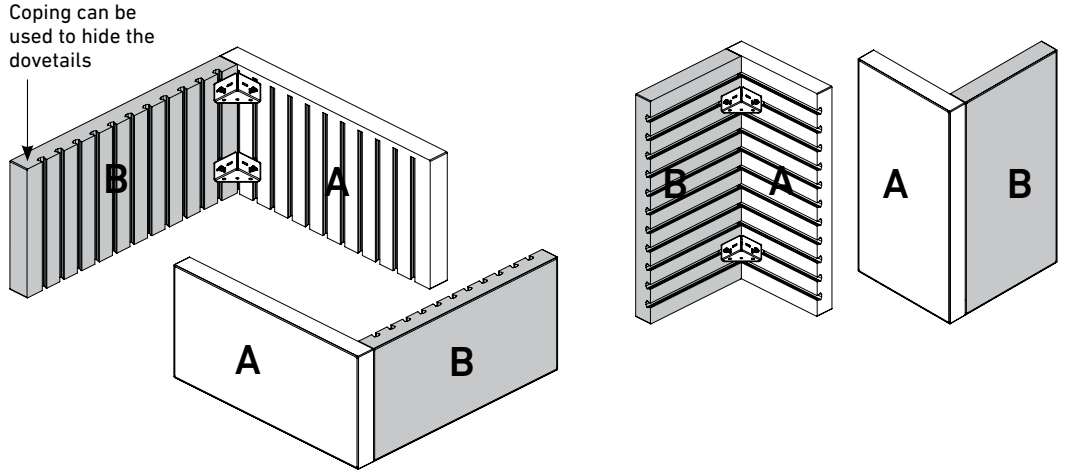

NOT OPTIMAL:

This configuration uses panel A only.

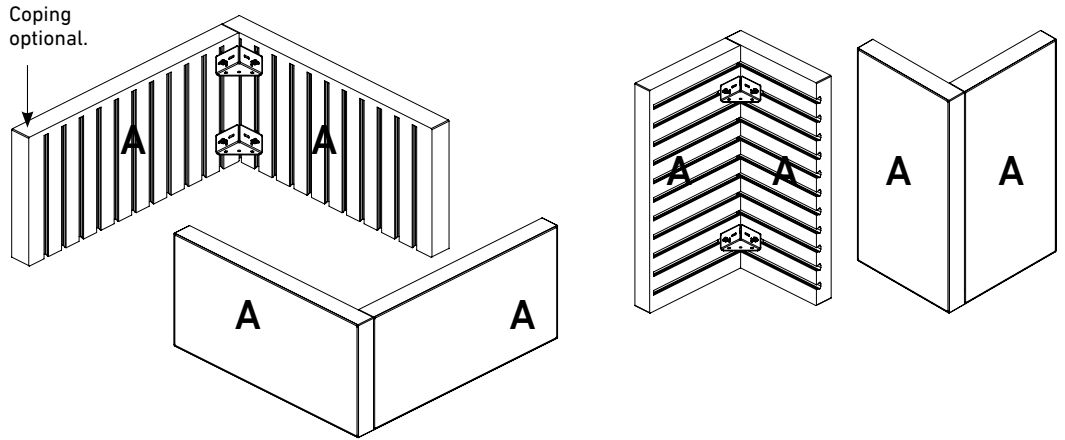

NOT RECOMMENDED:



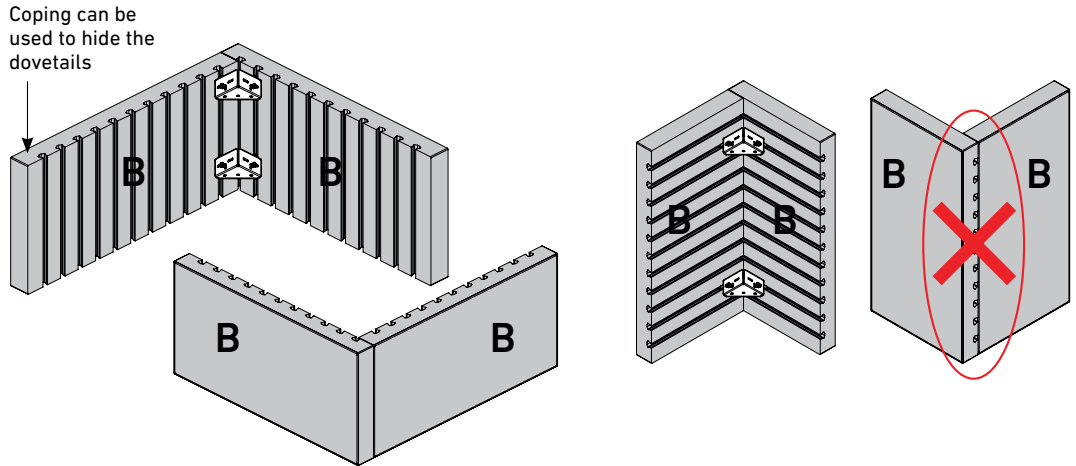

This configuration uses panel B only and the dovetails are exposed. Use ideal configuration as shown above.



*IMPORTANT: When planning configurations, consider the amount of panel A and panel B on a pallet. 18 x 36' panels are sold in pair/layer or in full pallet only. 6 x 36 panels are sold in layer or in full pallet only.



Scan for additional
product information

RESIDENTIAL	COMMERCIAL	STEPS	CAPS	COPING
				
✓	✓	✓		

SHAPES & SIZES

Step Unit



6 x 18 x 38





UNIT	SQFT/ PALLET	SQFT/ LAYER	LAYER/ PALLET	UNITS/ PALLET	UNITS/ SQFT	WEIGHT/ UNIT	WEIGHT/ PALLET
STEP UNIT							
6 X 18 X 38	-	-	-	8	-	2250	-

LANDINGS™ STEP UNIT

NATURAL
COLLECTION 



Scan for additional
product information

RESIDENTIAL	COMMERCIAL	STEPS	CAPS	COPING
				
✓	✓	✓		

SHAPES & SIZES

Step Unit



6 x 18 x 48

UNIT	SQFT/ PALLET	SQFT/ LAYER	LAYER/ PALLET	UNITS/ PALLET	UNITS/ SQFT	WEIGHT/ UNIT	WEIGHT/ PALLET
STEP UNIT							
6 X 18 X 48	–	–	–	6	–	460	2760



LANDINGS™ STEP UNIT INSTALLATION

Each Landings™ Step Unit is manufactured with two unique face patterns. The step units are palletized and packaged for easy skid-steer loader removal. Care needs to be taken in handling these units. If a blemish occurs on one side of unit, rotate 180° before setting unit into place.

BASE COURSE

Excavate an area 6 inches deep by 1 foot longer by 1 foot wider than the installed step(s) size. Add a minimum of 6 inches of compactable base material, 3/4-inch minus (with fines) aggregate. Compact and level. Set unit and, if desired, add a slight pitch of no more than 1/4 inch toward the front of the step to shed moisture. If installing step units next to a retaining wall, keep units level from front to back.

The Textures on Sides 1 and 2 are Designed to Nest with Minimal Gapping Between the Units.

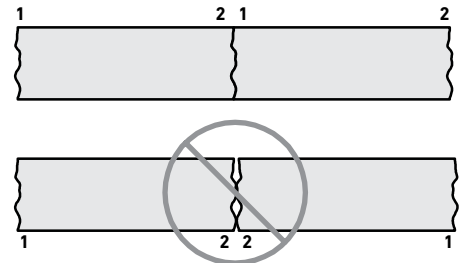

Place Units so They Nest Tightly Together.

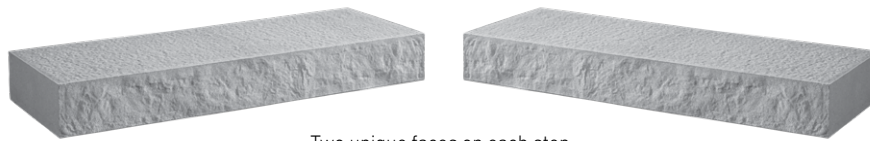

Two unique faces on each step

STAIR TREAD

For each consecutive step, follow base course instructions, making sure the top of the base is even with the top of the previously installed unit. Recommended tread depth is a minimum of 10 inches, but no more than 16 inches. When installing steps adjacent to a finished surface such as pavers, as illustrated, a 6-inch-tall dummy block needs to be installed below the first step.

LANDING

For landing(s) follow base course instructions. Each step unit is manufactured with two unique face patterns. The face patterns are manufactured to nest together, which will create a narrower joint, providing pleasing aesthetics.

STEPS IN A 90-DEGREE WALL

When building into a retaining wall, construct the steps first and build the walls adjacent to the steps.

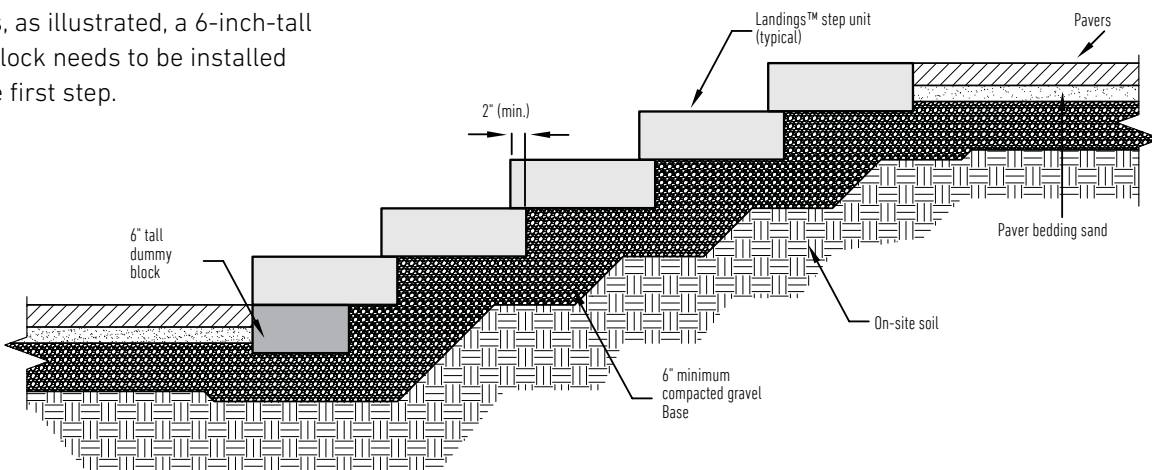

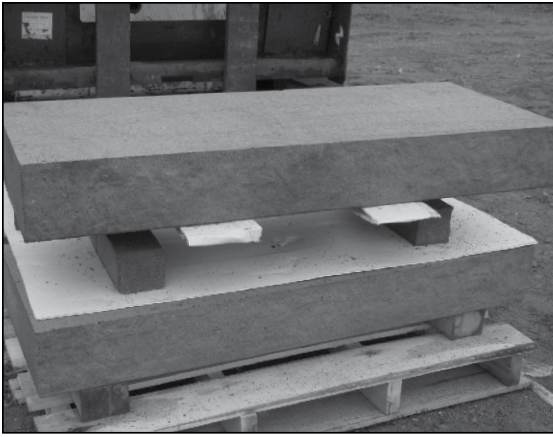

SKID-STEER LOADER

Slide forks underneath the first step unit and lift off pallet. Set the step unit onto its desired location, using a spacer to ease in fork removal.



A helpful tip to protect the step unit is to wrap the fork of the skid-steer with corrugated plastic packaging from the pallet or other protective materials. Secure to the forks.



CLAMP

Using a materials clamp, center the clamp on the step unit. Attach clamp to skid-steer or mini-excavator and slowly lift the step unit off of the pallet and move it into place. Be sure to have a second person to help guide the unit into place as the machine sets the step unit down.



STRAPS

When using a heavy duty strap(s), start by wrapping the strap(s) around the center if using one or close to step unit ends if two straps are being used. Cinch the strap(s) tight and attach the looped ends of the strap(s) to skid-steer or mini-excavator. Slowly lift the step unit from the pallet and move it into place. Be sure to have a second person to help guide the unit into place as the machine sets the step unit down. Using a spacer will help to ease in the strap removal.



CART





When using a cart, place provided corrugated plastic from pallet or other protective material onto the cart to help protect the step unit. With help from a second person, slowly slide the step unit from the pallet onto the cart. Maneuver the unit carefully into place.

Videos can be found on our YouTube channel:
www.youtube.com/anchorblockmn

MARINA™ COPING



Scan for additional product information

RESIDENTIAL	COMMERCIAL	STEPS	CAPS	COPING
				
✓		✓	✓	✓

SHAPES & SIZES

60mm

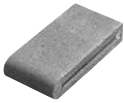

5¹⁵/₁₆ x 11¹³/₁₆ x 2³/₈

UNIT	SQFT/ PALLET	SQFT/ LAYER	LAYER/ PALLET	UNITS/ PALLET	SQFT/ UNITS	WEIGHT/ UNIT	WEIGHT/ PALLET
60mm							
5 ¹⁵ / ₁₆ X 11 ¹³ / ₁₆ X 2 ³ / ₈	97.5 LF	2.5 LF	5	195	0.5 LF	–	3608

MARINA COPING - POOL INSTALLATION

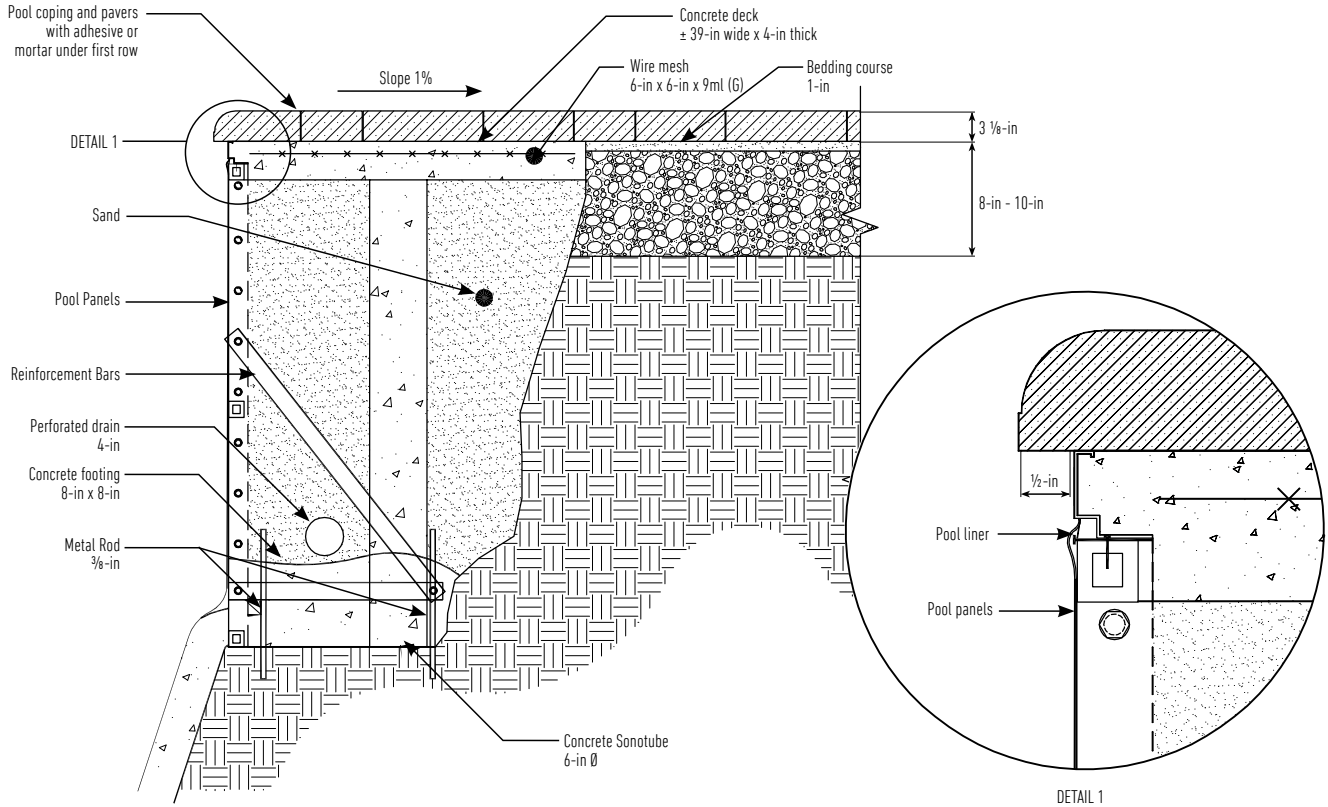

MARINA COPING - STEP INSTALLATION

OPTION 1

- A. Marina Coping
- B. Wall Block
- C. Grey block (4 in x 8 in x 16 in) or Wall Block

Note: All elements must be glued together with the concrete adhesive

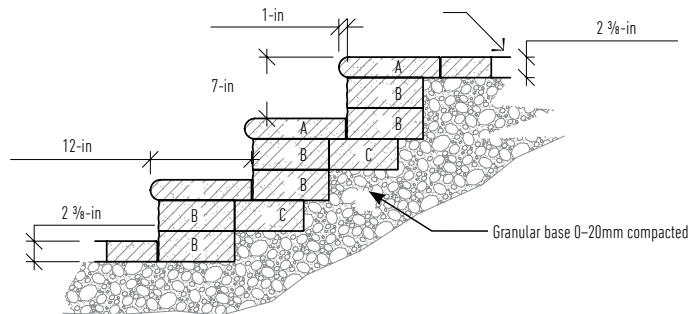

OPTION 2



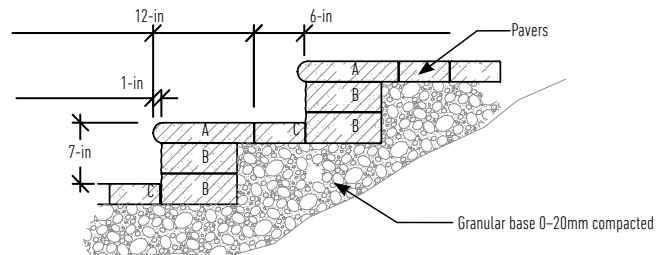

- A. Marina Coping
- B. Wall Block

Note: A & B elements must be glued together with the concrete adhesive.





Scan for additional
product information

RESIDENTIAL	COMMERCIAL	STEPS	CAPS	COPING
				
✓			✓	✓

SHAPES & SIZES

Fire Pit Cap*



56 Outside
36 Inside
Diameter x 2½

*4 pieces make a circle.

30 Inch Cap



30 x 30 x 2½

24 Inch Cap



24 x 24 x 2½

Seat Wall Cap

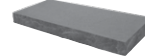

14 x 30 x 2½

UNIT	SQFT/ PALLET	SQFT/ LAYER	LAYER/ PALLET	UNITS/ PALLET	UNITS/ SQFT	WEIGHT/ UNIT	WEIGHT/ PALLET
------	-----------------	----------------	------------------	------------------	----------------	-----------------	-------------------

FIRE PIT CAP

56 Outside Diameter X 2½	–	–	–	8	–	75	626
-----------------------------	---	---	---	---	---	----	-----

PILLAR CAPS

30 X 30 X 2½	–	–	–	6	–	243	1512
24 X 24 X 2½	–	–	–	8	–	115	950

SEAT WALL CAP

14 X 30 X 2½	–	–	–	18	–	57	1080
--------------	---	---	---	----	---	----	------

BELGARD® | PAVES
THE WAY™

ASH GROVE
4201 Powell Drive
Bonner Springs, KS 66012
Ph: 913-667-1792
National Ph: 877-235-4273

STAY CONNECTED WITH BELGARD.



[Pinterest.com/Belgard](https://www.pinterest.com/Belgard)



[Facebook.com/OutdoorLivingbyBelgard](https://www.facebook.com/OutdoorLivingbyBelgard)



[Belgard.com/Blog](https://www.belgard.com/blog)



[YouTube.com/BelgardHardscapes](https://www.youtube.com/BelgardHardscapes)



[Twitter.com/Belgard](https://twitter.com/Belgard)



[Instagram.com/BelgardOutdoorLiving](https://www.instagram.com/BelgardOutdoorLiving)